

Automation for a Changing World

Delta Machine Vision System DMV Series Applications

Contents

Electronics 3

Printed Circuit Board (PCB) positioning	3
Inspection of C-type buckle installed in fan motors	5
Inspection of injecting glue length for motor magnets	7
Inspection of SMT material direction	9

Semiconductors 11

IC positioning Inspection	11
Inspection of damaged solar panels	13
Cell phone glass panel positioning	15
OCV inspection for laser engraving on semiconductors	17

Machine Tools 19

SMT socket blockage inspection	19
Finished workpiece inspection	20
Inspection of workpiece in the terminal blocks	21
Metal workpiece quality inspection	23

Automotive 25

Inspection of automobile A/C buttons	25
Inspection of laser scribed electrical resistance in automobiles	27
Chromed trim inspection	29
Exhaust pipe inspection	31

Rubber & Plastics 33

Plastic bottle cap positioning	33
Rubber washer inspection	35
Inspection of self-tapping screw on plastic workpiece	37
Plastic bottle and washer inspection	39

Packaging

41

Package barcode inspection	41
Coffee filter inspection	43
Inspection of face mask outer packages	45
Cosmetic sprayer inspection	47

Printing

49

Inspection of ink load for printing plates	49
Inspection of scratches on printed films	51
Inspection of printing quality on metal workpiece	53

Pharmaceuticals

55

Verification of expiration date (EXP) on medication bottles	55
Tablet quality inspection	57
Inspection of tag position on medication packaging	59

Other

61

Soldering spot coordinate identification on solar modules	61
Metal rivet inspection	63
Ceramic tile inspection	65
Inspection of hollow direction on metal workpiece	67

Electronics



Inspection Objectives

Printed Circuit Board (PCB) positioning

Using two cameras to locate a PCB from among others and precisely inspect its specifications

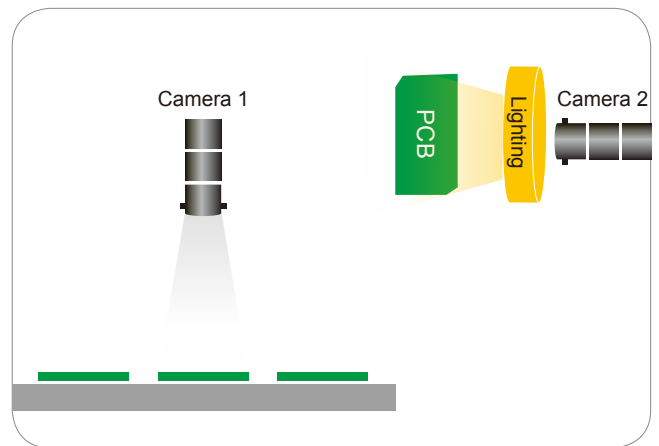

Device Configuration

Controller	DMV1000 (also applicable with DMV2000)		
Camera 1	DMV-CD80GS	Camera 2	DMV-CD80GS
Lens	12 mm focal length	Lens	12 mm focal length
Illumination	Backlight	Illumination	Front white ring light
Working distance	760 mm	Working distance	90 mm
FOV	300 mm x 225 mm	FOV	40 mm x 30 mm

【 Key Point 】

Using Camera 1 and 2 to locate and inspect a PCB:

- Camera 1 uses the "11-point learning" function to locate the PCBs inside the material tray, then uses the "Shape" function to guide the SCARA robot to pick up one of the PCBs
- Camera 2 uses the printed circuit of the PCB to operate the "Shape" function twice to obtain the X, Y and Θ coordinates and calculate the slight offset parameters for adjustment

【Result】

- Camera 1 is able to locate 10 pieces of PCBs' coordinates from a wide field of view (300 mm x 225 mm). The inspection time is within 500ms, and the precision is 2 mm.
- Camera 2 inspects the position of the specific PCB for further process with a narrowed field of view (40 mm x 30 mm). The inspection time is within 300ms, and the precision is 0.1 mm.

(The figure shows 5 pieces of PCB for demonstration)

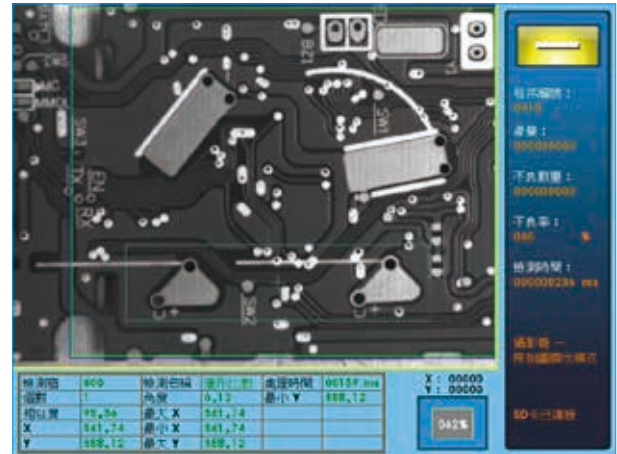
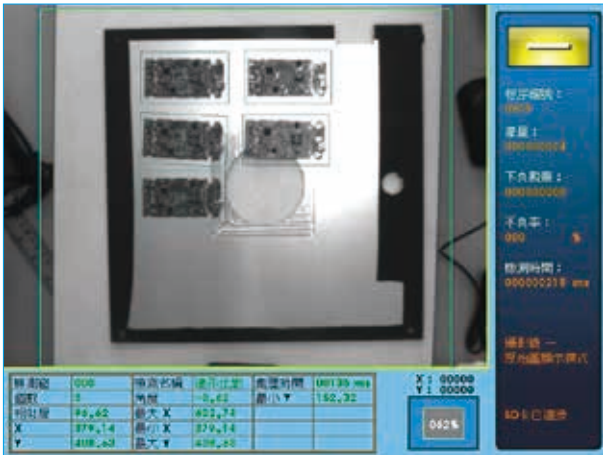

【Process】

- Camera 1 locates one of the PCBs and the SCARA robot picks up the PCB according to the inspection results
- The SCARA robot moves the PCB to Camera 2 for a more specific positioning and places the PCB into the electrical tester

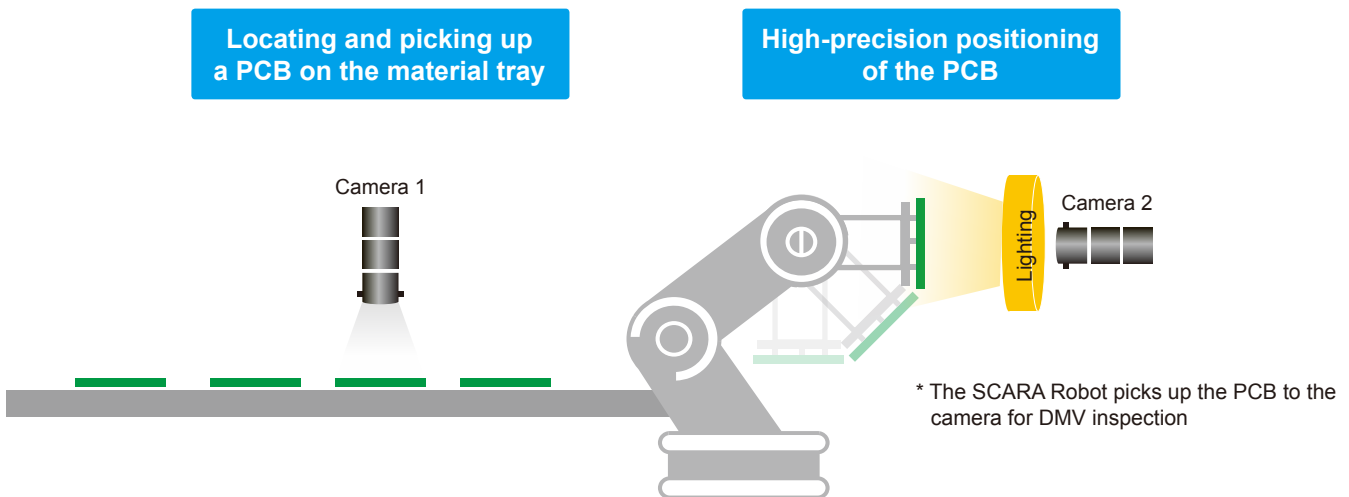

Advantages of DMV system

Using two cameras, this application fulfills requirements for locating and precise positioning of PCBs from a wide / narrow field of view

Electronics

Inspection Objectives

Inspection of C-shape buckle installed in fan motors

Using the DMV Series to inspect the installation of the C-shape buckle on the fan

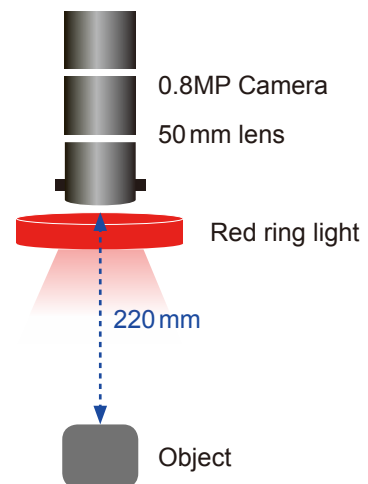
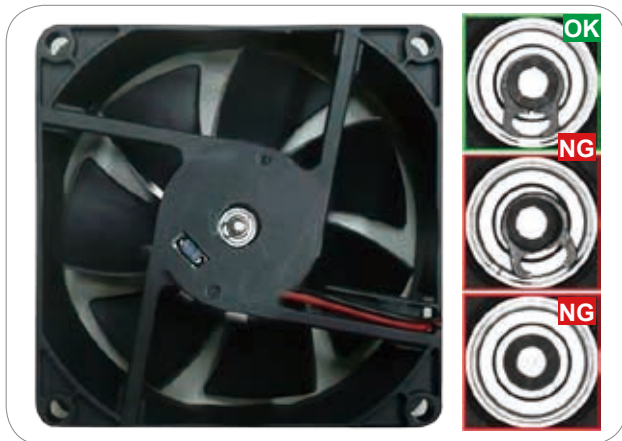

Device Configuration

Controller	DMV1000 (also applicable with DMV2000)
Camera	DMV-CD80GS
Lens	50 mm focal length
Illumination	Red ring light
Working distance	220 mm
FOV	16 mm x 12 mm

【 Inspecting Tool 】

Use the ring frame to locate inspection area, then use the "Edge Width" function to perform inspection

【 Key Point 】

Use the "Edge Width" function to inspect the two edges of the C-shape buckle, and calculate the angles. If the angle is too wide, it will be judged as an abnormal installation; if the result shows the angle difference is 0, it means the fan is not installed with any buckles

【Result】

- The angle difference of the two edges is 65.14, meaning the installation of the buckle is correct and the fan is judged as **OK**
- The angle difference of the two edges is 81.88, meaning the installation of the buckle is abnormal and the fan is judged as **NG**



- The angle difference of the two edges is 0, meaning the fan is without the buckle and judged as **NG**



【Process】

After the fan is installed with the C-shape buckle, the DMV Series will start inspecting. If the result shows OK, the fan will be sent to the next process; if NG, the fan will be removed

Advantages of DMV system

This application fulfills the requirement for automatic inspection after assembly

Electronics

Inspection Objectives

Inspection of injecting glue length for motor magnets

Using the DMV Series to inspect the magnet and the gluing amount

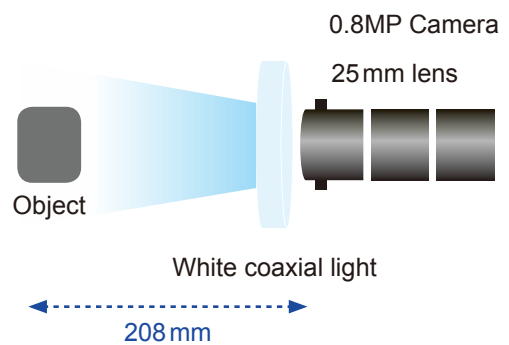

Device Configuration

Controller	DMV1000 (also applicable with DMV2000)
Camera	DMV-CD80GS
Lens	25mm focal length
Illumination	White coaxial light
Working distance	208 mm
FOV	40 mm x 30 mm

【 Inspecting Tool 】

Use the "Area" function to check whether the magnet is chipped, and then use the "Width Trace" function to check the gluing length

【 Key Point 】

The lighting should make the contrast of the gluing image prominent

【Result】

- The three gluing lengths (from top to bottom) are 374, 389, and 414
- If there is no glue on the magnet, the inspection result is 0. If the magnet has chips, more white zones will be revealed by the DMV system



【Process】

Using the DMV Series to inspect the magnets helps remove the chipped ones and glue the intact ones. It can also check the glue length and removes the defect products to ensure smooth assembly

Advantages of DMV system

This application fulfills the requirement for automatic inspection of the semi-product line

Electronics



Inspection Objectives

Inspection of SMT material direction

By using the DMV Series to inspect the direction of the material, the controller will trigger an output to inform operators for alert when the material is reversed or upside down

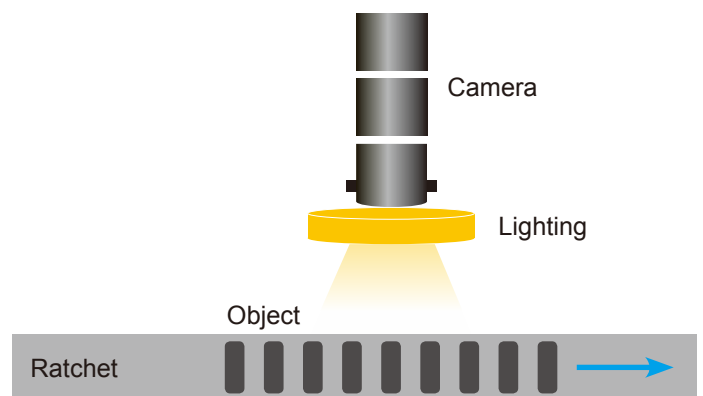

Device Configuration

Controller	DMV1000 (also applicable with DMV2000)
Camera	DMV-CD80GS
Lens	12 mm focal length
Illumination	75/46 low-angle ring light
Working distance	90 mm
FOV	40 mm x 30 mm

【 Inspecting Tool 】

Use the "Shape" function to locate the printed "DELTA" characters on the material

【 Key Point 】

Since the "DELTA" characters on the material are printed black on white with clear contrast, the "Shape" function is able to perform stable and consistent results

【Result】

- Inspection speed: within 150 ms
- The DMV Series identifies the material direction according to the matching rate of "DELTA" characters: up to 98% if the direction is correct / below 60% if opposite or back-sided

Correct direction **OK**



Opposite direction **NG**



Back side **NG**



【Process】

By using step motors to drive the ratchets of the SMT carrier, each material is sent one by one to pass under the camera. If an NG material is detected, the machine will stop and wait for for removal

Advantages of DMV system

The "Shape" function of the DMV Series allows consistent inspection results

Semiconductor

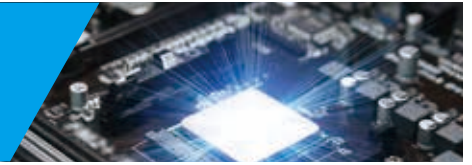

Inspection Objectives

IC positioning Inspection

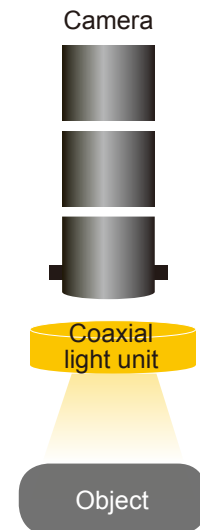
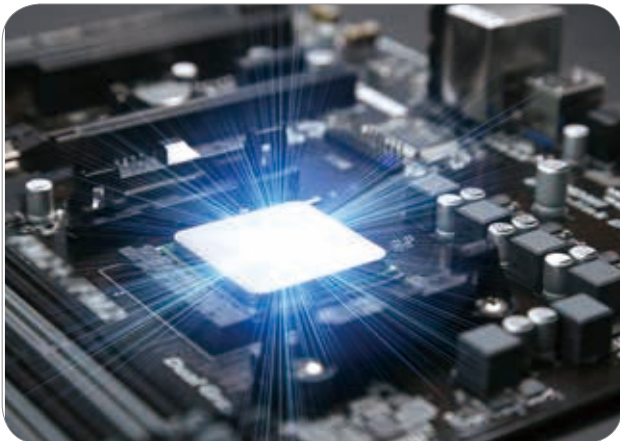

Device Configuration

Controller	DMV1000 (also applicable with DMV2000)
Camera	DMV-CD80GS
Lens	50 focal length
Illumination	Red coaxial light unit
Working distance	Approx. 210mm
FOV	Approx. 17mm x 12.8mm

【Inspecting Tool】

Use the "Shape" function to measure coordinates and shifting angles of IC chips

【Key Point】

Illumination has to strengthen the outline of the IC chip to enhance the positioning accuracy of the DMV system

【Result】

- Inspection speed: within 300 ms
- The DMV Series inspects the position of the IC chip sent to the inspection area and then identifies its coordinates

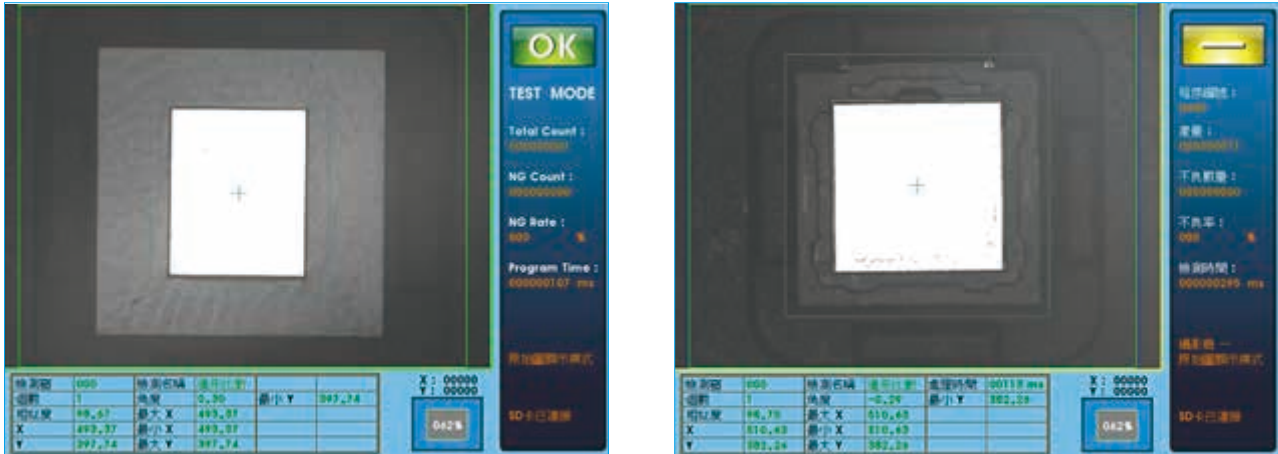

【Process】

- When an IC chip is sent to the inspection area, the PLC triggers the DMV Series to take a photo
- The PLC receives the inspection results every 200 ms via communication during DMV system operation, and controls the SCARA robots to pick and place the IC chips based on the results

Advantages of DMV system

This system is customized to fulfill customers' requirements of labor cost reduction and production efficiency enhancement, as well as lowering the rate of manually damaged products

Semiconductors

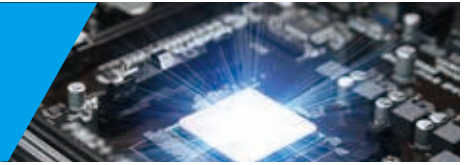

Inspection Objectives

Inspection of damaged solar panels

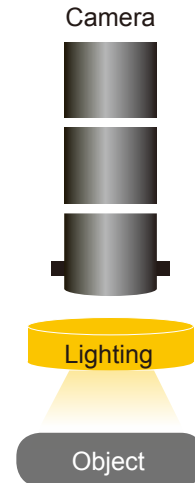

Device Configuration

Controller	DMV1000 (also applicable with DMV2000)
Camera	DMV-CD80GS
Lens	8mm focal length
Illumination	150mm red ring light at 60 degree + diffusion plate
Working distance	Approx. 400mm
FOV	Approx. 240 mm x 180 mm

【Inspecting Tool】

- Use the "Shape" function to position solar panels
- Based on the position result, use 8 "Position Trace" functions to identify whether the edge of the solar panel is damaged

【Key Point】

The "Position Trace" function offers 2 defect inspections: "Depth of Damage" and "Area"

Shallow depth / wide area: "Area" inspection

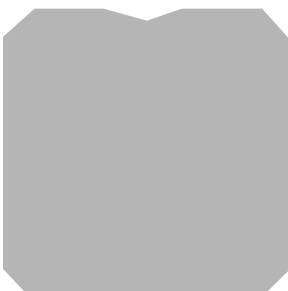

Deep depth / small area: "Depth of Damage" inspection



【Result】

- Inspection speed: within 800 ms
- The system stably inspects damaged spots of approx. 1 mm (customer's requirement: damage inspection within the range of 2 mm)

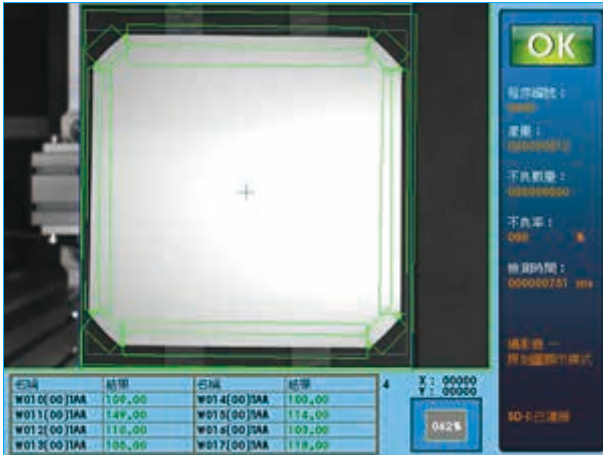

【Process】

- Solar panels are sent to the inspection area (under the camera)
- The master controller triggers the camera to take a photo. The DMV Series inspects the image in the photograph and identifies if the solar panel is damaged by showing OK/NG within 800 ms. If the result shows NG, the defective panel will be removed in the next process

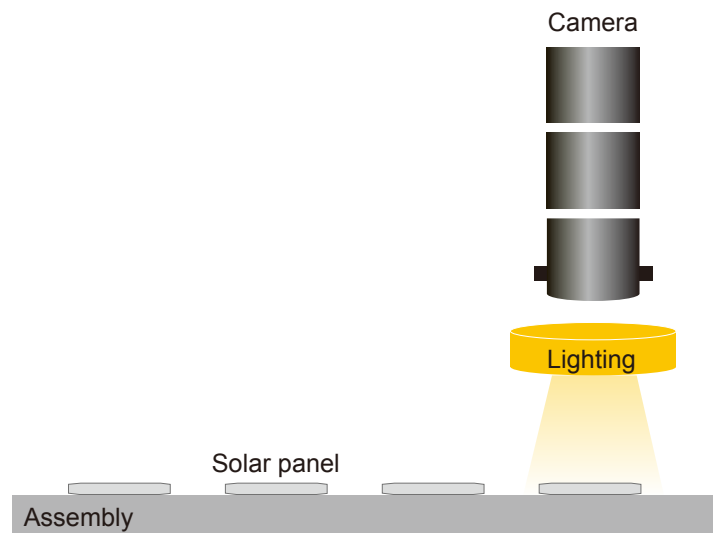

Advantages of DMV system

Damaged solar panels are easily missed by human visual inspection. With the "Position Trace" of the DMV Series, damaged solar panels can be stably and correctly detected and removed to enhance production efficiency and yield rate

Semiconductors



Inspection Objectives

Cell phone glass panel positioning

With the DMV Series positioning cell phone panel glass (within 1 mm accuracy), the SCARA robot picks up the object

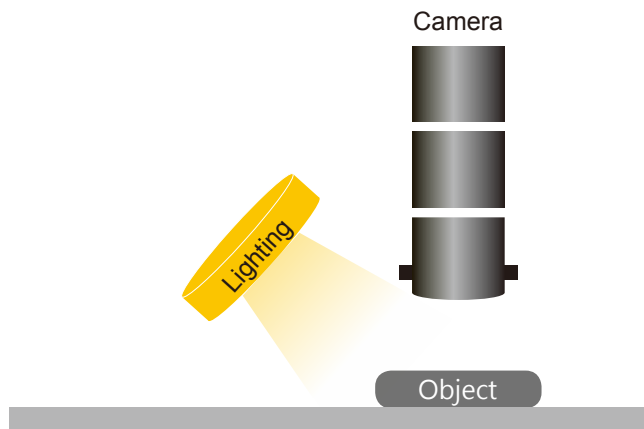

Device Configuration

Controller	DMV1000 (also applicable with DMV2000)
Camera	DMV-CD80GS
Lens	8mm focal length
Illumination	Side Bar light
Working distance	670 mm
FOV	400 mm x 300 mm

【 Inspecting Tool 】

Use the "Shape" function to position cell phone panel class

【 Key Point 】

- When matched with the SCARA robot, the "4-point learning" function is enacted to transform the visual coordinates to the SCARA robot coordinates
- Even illumination is necessary for the best inspection result

【Result】

- Inspection speed: within 700 ms
- The positioning accuracy can be controlled within 1 mm with even illumination from 4 directions

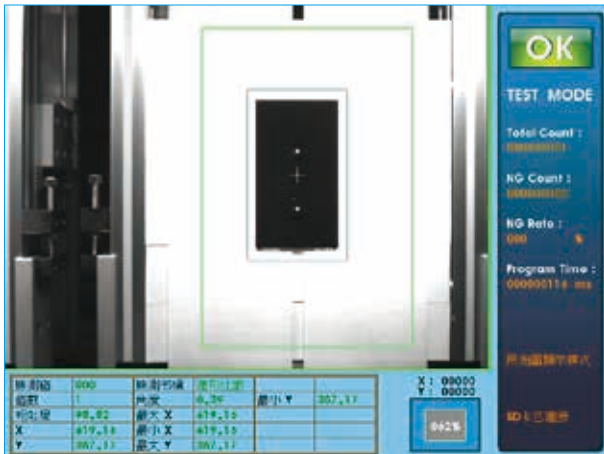

【Process】

When the panel class is delivered to the inspection area, the DMV Series is triggered to take photos, and transforms the visual coordinates to the SCARA coordinates. The SCARA robot picks up the object based on the SCARA coordinates

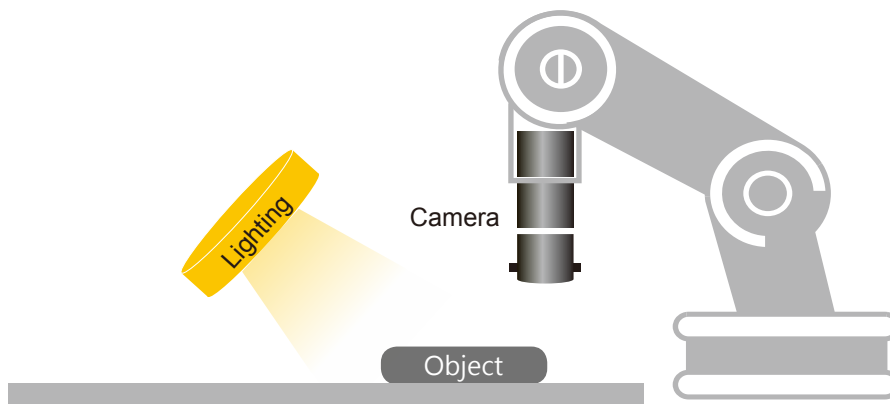

Advantages of DMV system

To integrate SCARA robot and the DMV system to achieve unmanned automation

Semiconductors



Inspection Objectives

OCV inspection for laser engraving on semiconductors

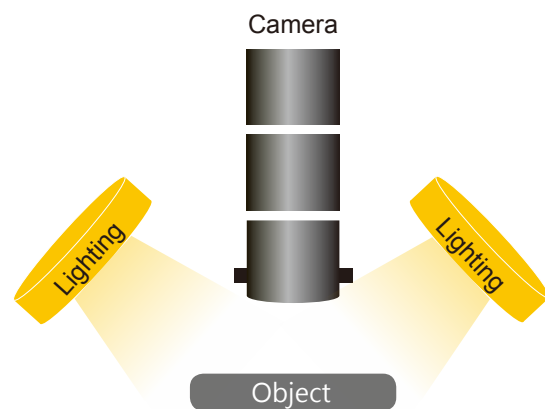

Device Configuration

Controller	DMV1000 (also applicable with DMV2000)
Camera	DMV-CD80GS
Lens	25mm focal length
Illumination	100mm white bar light + diffusion plate x 2
Working distance	Approx. 300mm
FOV	Approx. 60mm x 45mm

【Inspecting Tool】

- Use the "Shape" function to position the wafer holder
- Based on the position result, use the "OCV" function to detect characters

【Key Point】

- The laser engraved characters can be clearly shown with lighting that provides the most contrast
- After setting up the environment for image capture, add the characters into the database, and then use the "OCV" function in the DMV Series for character detection

【Result】

- Inspection speed: within 800 ms
- The DMV Series can detect up to 2 lines of characters (22 characters each line)



【Process】

- The SCARA robot takes the object to the inspection area
- After the camera captures images, the computer reads the character detection result via the RS-232 communication interface

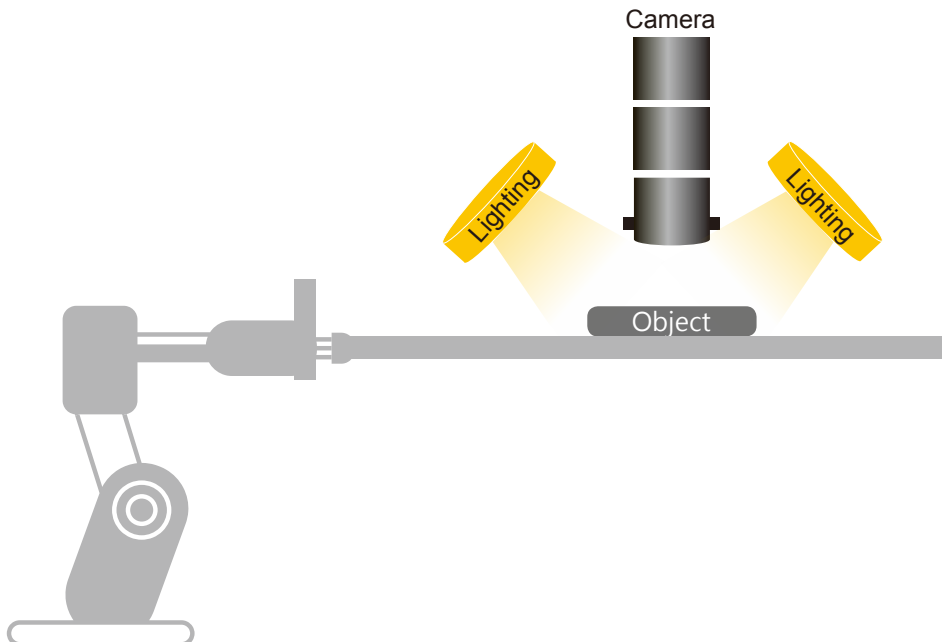

Advantages of DMV system

The DMV Series stably detects up to 2 lines of characters (with 22 characters each line) for production status monitoring

Machine Tools



Inspection Objectives

SMT socket blockage inspection



Device Configuration

Controller	DMV1000 (also applicable with DMV2000)
Camera	DMV-CD80GS
Lens	110mm, 2 x parallel optical lens
Illumination	4218 white top ring light
Working distance	110 mm
FOV	2.4 mm x 1.8 mm

【Inspecting Tool】

- Use "Area" function
- The blockage spot is shown as a white area, by which the DMV Series can determine whether the socket is blocked by calculating the white area

【Result】

- Inspection speed: within 200 ms
- Stably inspected when over 1/5 of the socket diameter is blocked

【Key Point】

Illumination angle is crucial. When lighting is set at the correct position, the blob of the blockage spots will be shown in white image clearly

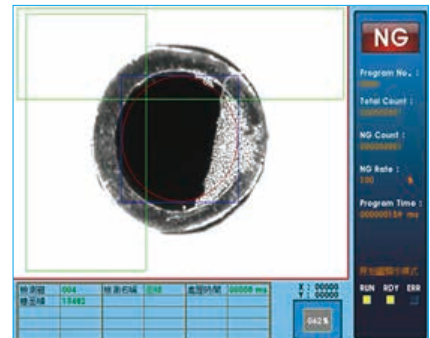

【Process】

- Camera and illumination are above the object; direct lighting is used for image captures
- The installation hole of each type of socket is identical in size. Create a standard hole on the workstation, and then manually place the sockets onto it for inspection

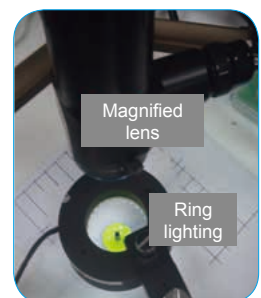

Advantages of DMV system

Because the size of the socket is small and difficult for inspection, magnification lens and strengthening light are needed for stable inspection

Machine Tools



Inspection Objectives

Finished workpiece inspection

Confirming presence of tap in workpiece with the DMV system



Device Configuration

Controller	DMV1000 (also applicable with DMV2000)
Camera	DMV-CD80GS
Lens	Lens 160mm focal length + 8mm extension ring
Illumination	Red ring light
Working distance	19 mm
FOV	10 mm x 7 mm

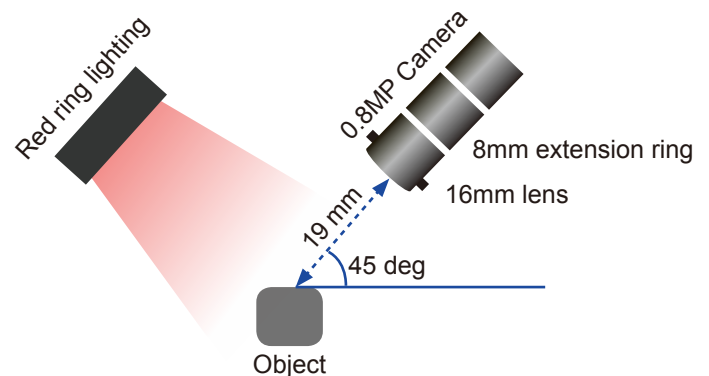

【Inspecting Tool】

Use "Edge Count" function

【Key Point】

The lens must be installed at a tilt to inspect the presence of taps, and illumination is needed to create enough contrast over the screw threads

【Result】

The DMV system detects certain amounts of edge quantity to confirm the presence of taps

【Process】

Inspection starts after placing the workpiece onto the workstation



Advantages of DMV system

Fulfills the requirement for real-time auto inspection right after assembly

Machine Tools



Inspection Objectives

Inspection of workpiece in the terminal blocks

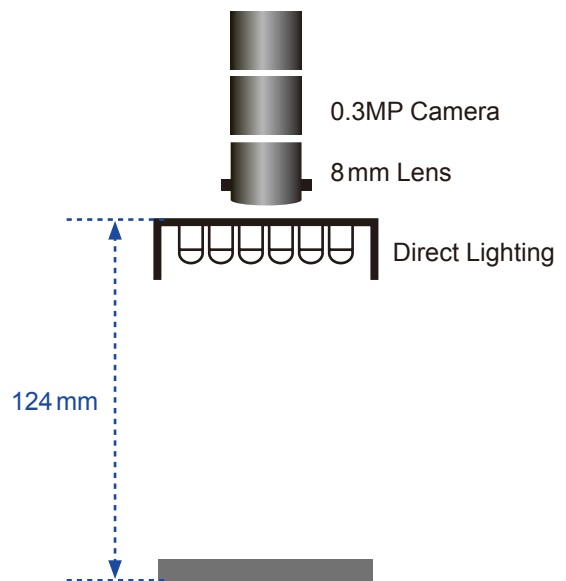
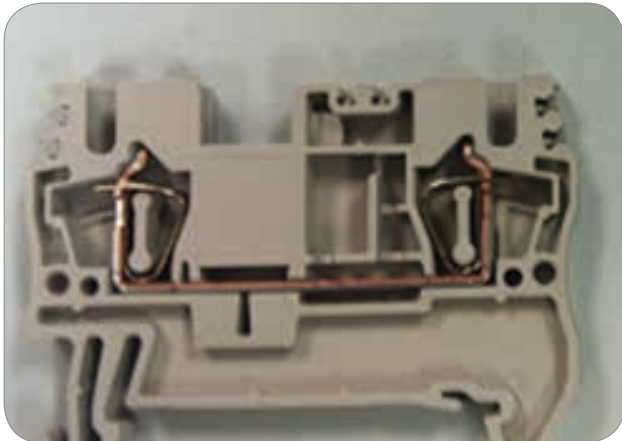

Device Configuration

Controller	DMV1000 (also applicable with DMV2000)
Camera	DMV-CD30GS
Lens	8mm focal length
Illumination	Direct Lighting
Working distance	124 mm
FOV	49 mm x 35 mm

【Inspecting Tool】

- Use the "Shape" function to initially position terminal blocks
- Use multiple "Area" functions to confirm whether the workpiece is found

【Key Point】

Direct vertical illumination must be used to achieve maximum reflectivity of the workpiece

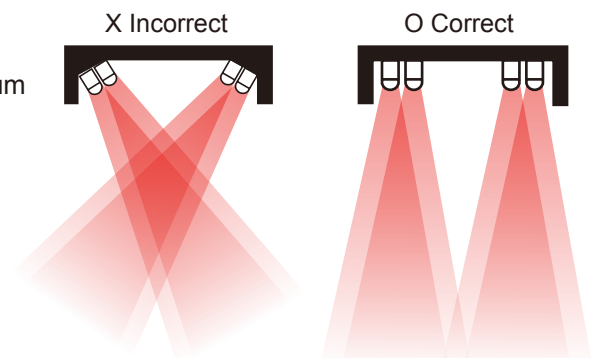

【Result】

- Use 3 "Area" functions to detect a certain amount of white blob when the workpiece is present
- If the workpiece is not assembled, those 3 "Area" functions can only detect a smaller area of white blob

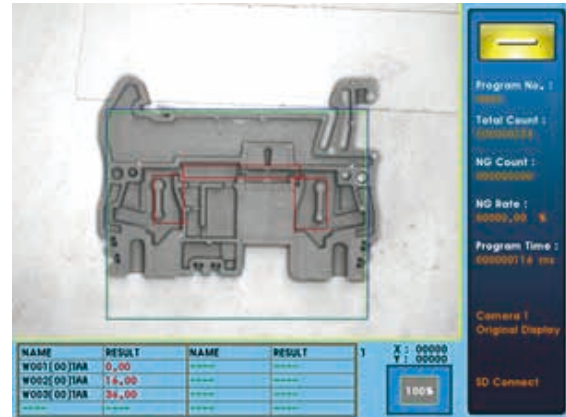
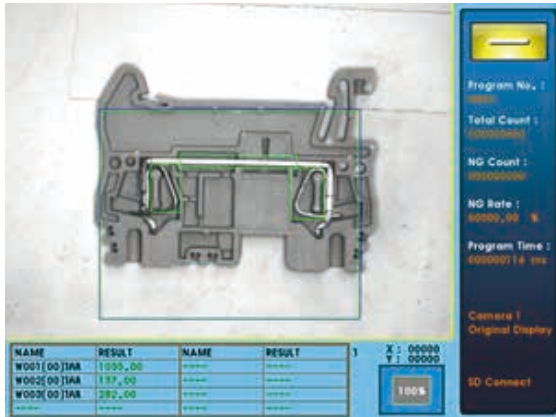

【Process】

The finished terminal blocks will be delivered via conveyors to the area for machine vision inspection. Terminal blocks with the target workpiece found will continue, whereas the ones without the target workpiece found will be discarded

Advantages of DMV system

Fulfills the requirement for real-time auto inspection right after terminal blocks are assembled at the production line

Machine Tools



Inspection Objectives

Metal workpiece quality inspection

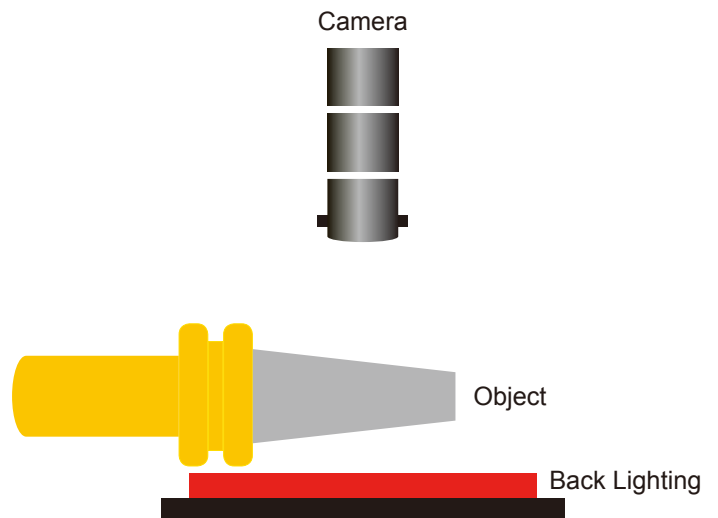

Device Configuration

Controller	DMV1000 (also applicable with DMV2000)
Camera	DMV-CD80GS
Lens	8 focal length
Illumination	Red back lighting
Working distance	Approx. 158 mm
FOV	Approx. 100 mm x 75 mm

【 Inspecting Tool 】

- Use the "Edge Position" function to position the metal workpiece in the screen
- Use the "Position Trace" function at the positioning area to measure the length of the metal workpiece's cone section

【 Key Point 】

The angle of camera set up is crucial for a tilted camera may cause size inspection inaccuracies

【Result】

- Inspection speed: within 200ms
- When the SCARA robot sends a metal workpiece to the inspection area, the DMV system inspects from the side to measure if the distance from the tip to the bottom of the metal workpiece is within the standard range
- Use the "Edge Position" function to get the Y coordinate of the workpiece by scanning vertically, and then get the X coordinate by scanning horizontally

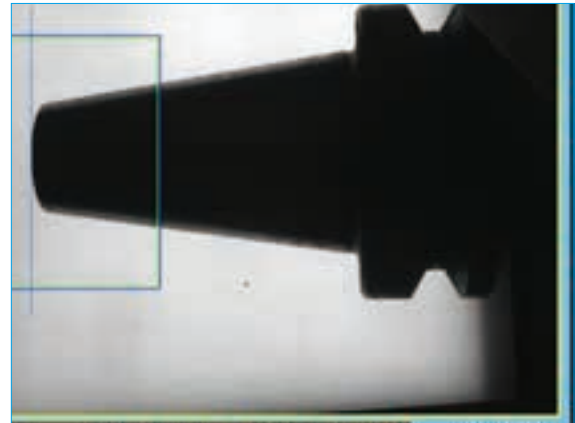

- Use the "Position Trace" function to get the coordinates of the tip and bottom of the cone for distance calculation



【Process】

- When a workpiece is sent to the inspection area, a PLC triggers the DMV Series to take photos
- The PLC receives the inspection results every 200 ms via communication during the DMV system operation, and continues the process or discards the defects based on the results

Advantages of DMV system

This solution fulfills customer's requirement of using the DMV Series to assist in standardizing the distance from the tip to the bottom of the workpiece, reducing defective products

Automotive



Inspection Objectives

Inspection of automobile A/C buttons

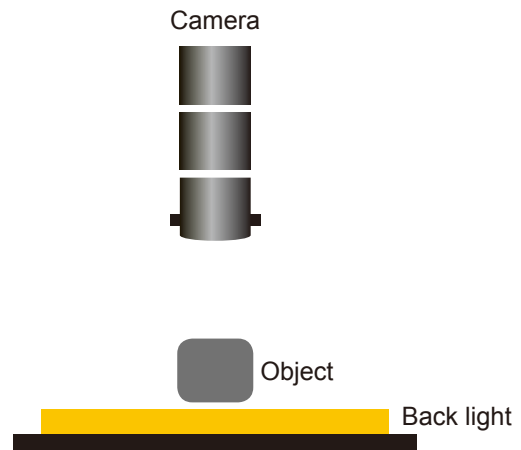

Device Configuration

Controller	DMV1000 (also applicable with DMV2000)
Camera	DMV-CD80GS
Lens	25 focal length + 2 mm extension ring
Illumination	Red back light
Working distance	Approx. 168 mm
FOV	Approx. 32.5 mm x 24.4 mm

【 Inspecting Tool 】

- Use the "Shape" function to position the image in the button
- Use the "Area" and the "Intensity" functions to calculate the enlightened area of the man icon and the downward arrow

【 Key Point 】

Cameras must be triggered only when the object completely enters the inspection area in order to avoid misjudgment

【Result】

- Inspection speed: within 200 ms
- When an automobile air conditioner button enters the inspection area, the DMV Series captures its images; use the "Shape" function to acquire its X, Y coordinates and rotation angle, and then use the "Area" function to examine if it contains any extra enlightened area
- When a defect is inspected, the system will send a NG signal to the controller



- The "Area" function inspects an extra enlightened area of 664 pixels (an extra arrow) which exceeds the standard range and is recognized as a defect



【Process】

- When the object enters the inspection area, the controller will trigger an output to take photos and complete the inspection within 200 ms
- Then the defects will be picked out based on the result sent by the controller

Advantages of DMV system

The DMV integration enhances production efficiency and reduces defect rate

Automotive



Inspection Objectives

Inspection of laser scribed electrical resistance in automobiles

Detects the position of 3 electrical resistors with the DMV Series for precise laser scribing

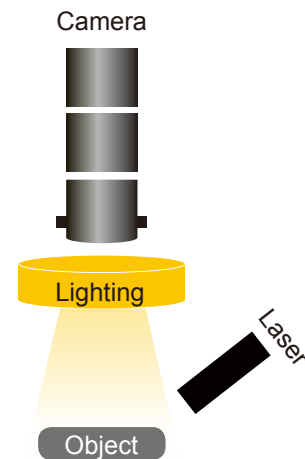
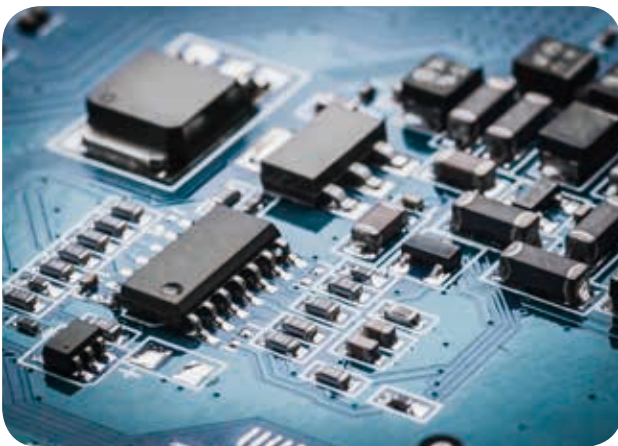

Device Configuration

Controller	DMV1000 (also applicable with DMV2000)
Camera	DMV-CD80GS
Lens	12 mm focal length
Illumination	6736 white ring light
Working distance	160 mm
FOV	100 mm x 75 mm

【 Inspecting Tool 】

Use the "Shape" function to position, and then use 3 "Blob" functions to find the location of black electric resistors

【 Key Point 】

Use the "Shape" function to position the default coordinates in order to precisely perform laser scribing

【Result】

- Inspection speed: within 500 ms
- Positioning accuracy maintains within 0.5 mm to meet customer requirements



【Process】

- After manually placing the object, the DMV Series acquires their X-Y coordinates for the controller to perform precise laser scribing

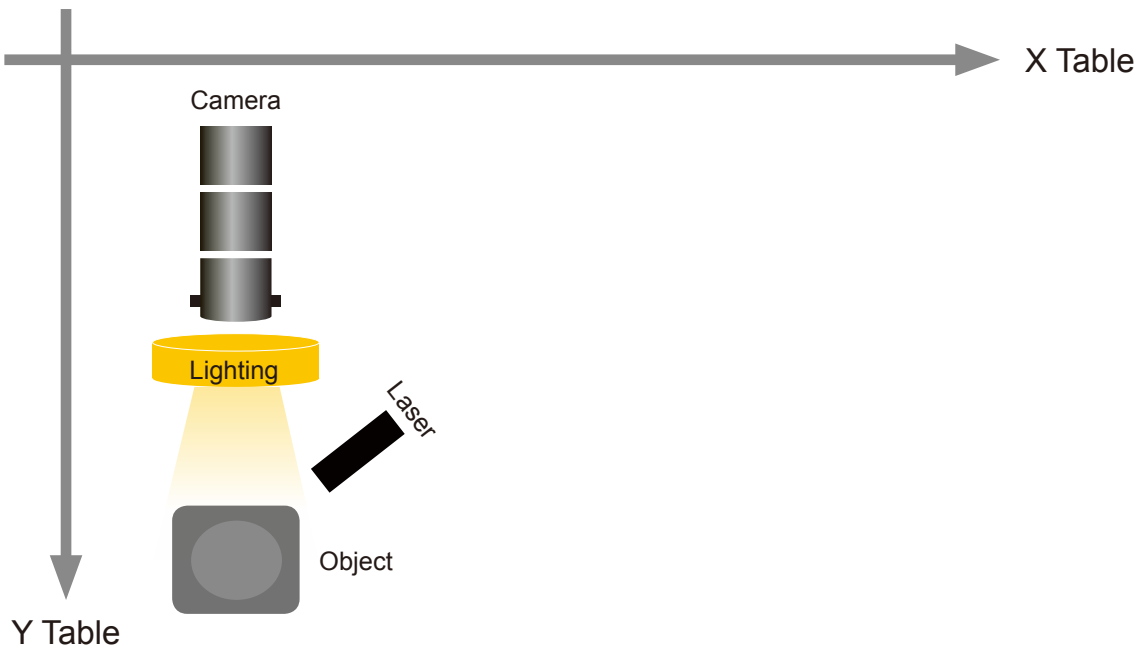

Advantages of DMV system

Offsets and unstable quality are often found in manual laser scribing process. The use of DMV Series helps to enhance production speed and precision, and ensure constant product quality

Automotive



Inspection Objectives

Chromed trim inspection

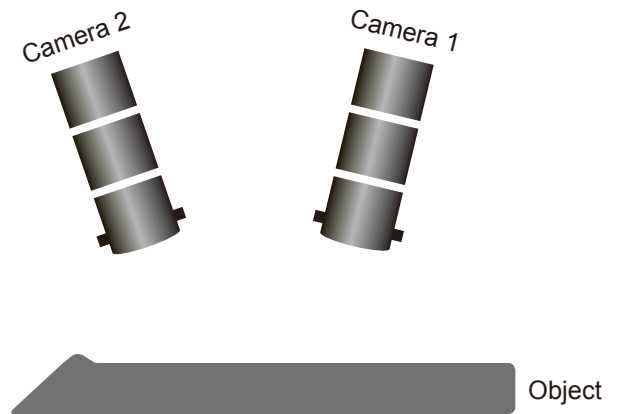

Device Configuration

Controller	DMV1000 (also applicable with DMV2000)
Camera	DMV-CD80GS
Lens	8 mm focal length x 2
Illumination	Ambient light
Working distance	600 mm for camera 1 and 2
FOV	370 mm x 277 mm

【 Inspecting Tool 】

- Use 2 "Shape" functions to position the chromed trim
- Use 6 "Area" functions to inspect whether the washers are correctly installed on it

【 Key Point 】

- The installation height of the two cameras is crucial for capturing images of each half of the washers on the chromed trim
- As the car chromed trim reflects easily, avoid reflection when casting light

【Result】

- Inspection speed: within 500 ms
- The number of the washers in car chromed trim can be correctly inspected (black washers installed above white washers)
- Black washer installation inspection: use the "Area" function to inspect washer installation spots. As the images shown below: when a black washer is correctly installed, the black area value is 1,181 pixels; when there is no black washer and a white washer beneath it is exposed, the black area value is only 241 pixels, which is below the normal value



- White washer installation inspection: use the "Area" function to inspect washer installation spots. As in the images shown below: when a white washer is correctly installed, the white area value is 1030 pixels; when the white washer is removed, the white area value diminishes to 252 pixels



【Process】

- When the worker completes assembly, the DMV Series starts to take photos
- The DMV Series sends the OK/NG signals to the controller via I/O communication. If the result shows NG, the controller will trigger an output to inform operators for alert

Advantages of DMV system

The DMV system effectively helps the automobile component manufacturer to identify accurate installation of washers on the chromed trims, greatly reducing defect rate

Automotive



Inspection Objectives

Exhaust pipe inspection

Use the DMV Series to inspect the digits on the pipe side and the fiber glass pack placed in the pipe

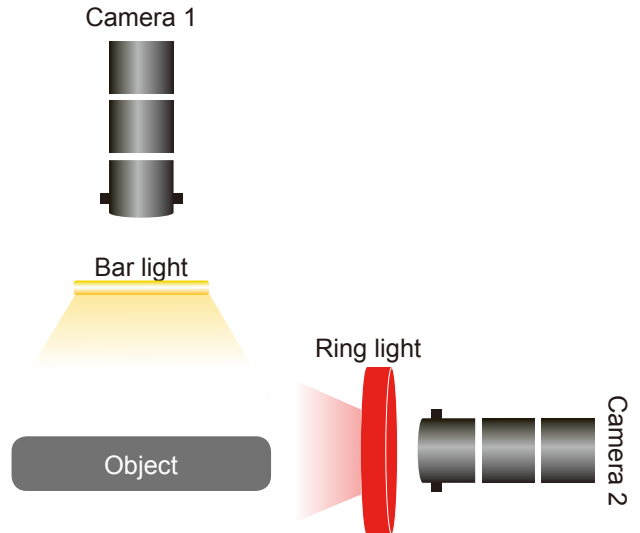

Device Configuration

Controller	DMV1000 (also applicable with DMV2000)		
Camera 1	DMV-CD80GS	Camera 2	DMV-CD80GS
Lens	12mm focal length	Lens	8mm focal length
Illumination	LED bar light *2	Illumination	Red ring light
Working distance	763mm	Working distance	333mm
FOV	300mm x 225mm	FOV	200mm x 150mm

【 Inspecting Tool 】

- 2 Cameras are used for this application. Camera 1 uses the "Shape" function to position the pipe, and then use the "Area" function to confirm whether the pipe contains a fiber glass pack inside
- Camera 2 uses the "Shape" function to position the digits on the side of the pipe, and then use 2 "Shape" functions to confirm whether the numbers steel printed on the pipe side are correct
- Use the "Blob" function to recognize dual-pipe or triple-pipe

【 Key Point 】

- The lighting needs to contrast the characters on the workpiece surface
- Positioning functions are suggested to apply to prevent offset

【Result】

1. Camera 1 uses the "Shape" function to position



2. Use the "Area" function to inspect the placement of the fiber glass pack

(When the fiber glass pack is placed, the total white area value is 14,167 pixels)



3. Camera 2 uses the "Shape" function to position

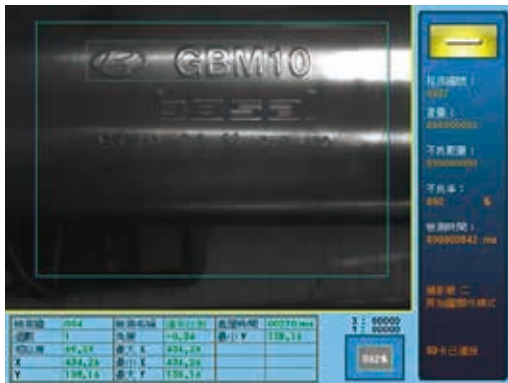

4. Confirm the characters with the "Shape" function

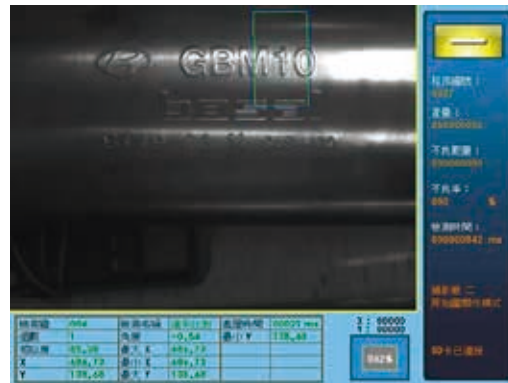

5. Use the "Shape" function to examine whether the steel print is present

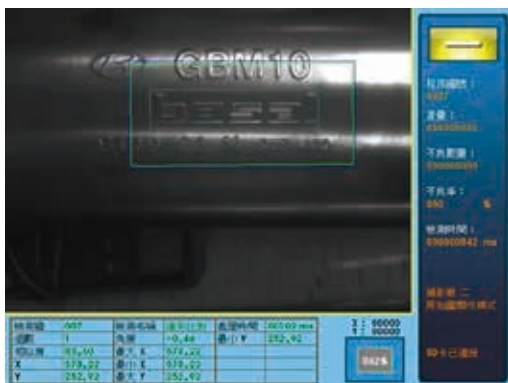

【Process】

- When a workpiece is sent to the inspection area, the DMV Series starts to take photos
- The DMV Series sends the OK/NG signals to the controller via I/O communication. If the result shows NG, the controller will trigger an output inform operators for alert

Advantages of DMV system

The DMV Series effectively prevents incorrect feeding and reduces material waste

Rubber and Plastics



Inspection Objectives

Plastic bottle cap positioning

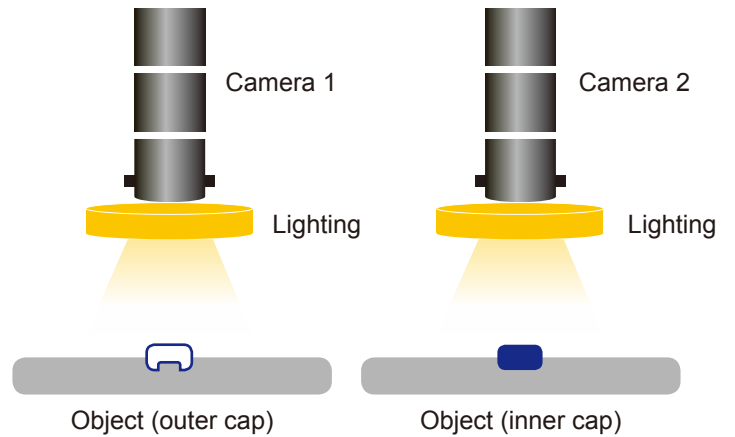

Device Configuration

Controller	DMV1000 (also applicable with DMV2000)
Camera	DMV-CD80GS
Lens	12 mm focal length
Illumination	White ring light, front lighting
Working distance	200 mm
FOV	80 mm x 60 mm

【 Inspecting Tool 】

Two cameras and the "Shape" function are used for this application to obtain the coordinates and the angle of the plastic cap

【 Key Point 】

Uses the white ring light for front lighting to receive better image quality

【Result】

- Inspection speed of inner and outer caps: within 230 ms
- After testing, the DMV Series is able to ensure the position angle difference of the outer and inner caps within 1 mm and 0.5 degree during assembly (customer's demand: less than 2 mm)

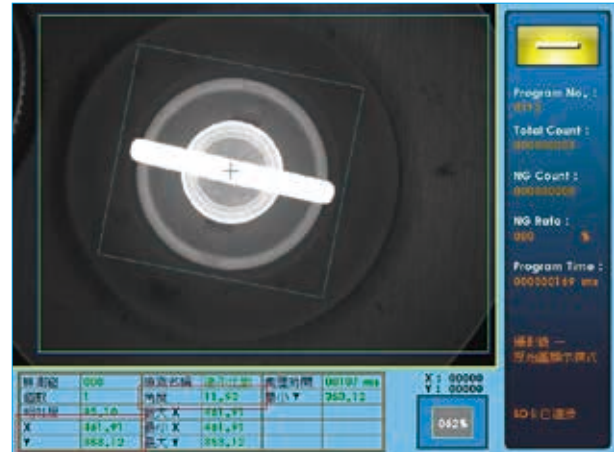
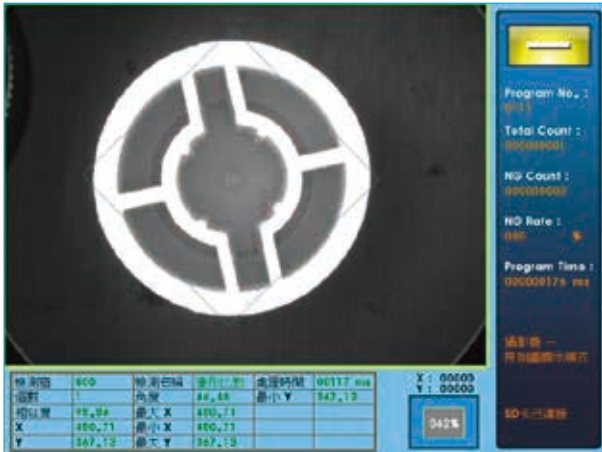

【Process】

- Uses 1 DMV controller with 2 cameras to capture images
- After camera 1 receives the coordinates and the angle of the outer cap, the robot will pick up the outer cap. Then camera 2 locates the coordinates of the inner cap, and the robot will assemble the outer cap to the inner cap according to the two detection results

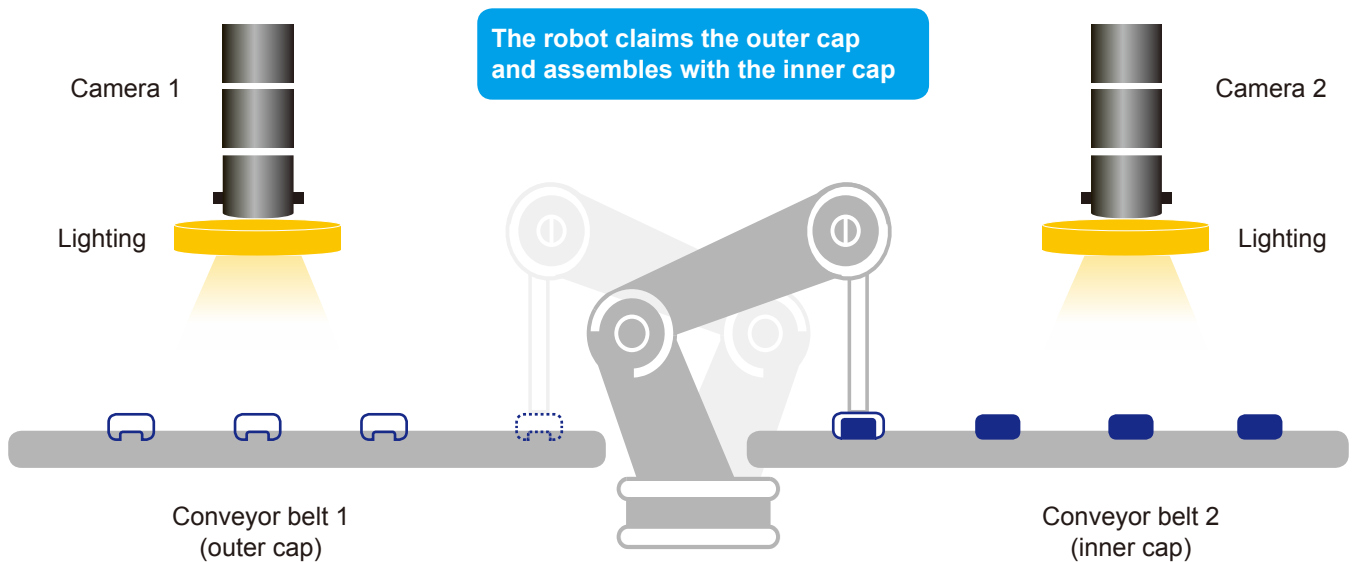

Advantages of DMV system

The integration of the DMV Series and industrial robots effectively reduces labor cost

Rubber and Plastics



Inspection Objectives

Rubber washer inspection

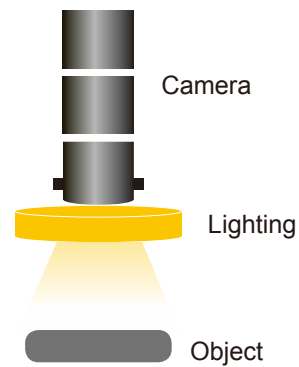

Device Configuration

Controller	DMV1000 (also applicable with DMV2000)
Camera	DMV-CD80GS
Lens	25mm focal length
Illumination	Red ring light
Working distance	Approx. 208 mm
FOV	Approx. 40 mm x 30 mm

【 Inspecting Tool 】

- Use 2 "Edge Position" functions to locate the rim of the rubber gasket
- Then use 2 "Position Trace" functions to inspect whether the inner rim, outer rim and the whole rubber gasket meet the standard

【 Key Point 】

This application requires inspection of three parameters of a rubber gasket: the inner diameter, the outer diameter and the roundness

【Result】

- Inspection speed: within 200 ms
- Use the "Position Trace" function to scan the inner rim of the rubber gasket and check whether the radius and the roundness meet the standard
- Then use another "Position Trace" function to scan the outer rim of the rubber gasket and check whether the radius and the roundness meet the standard

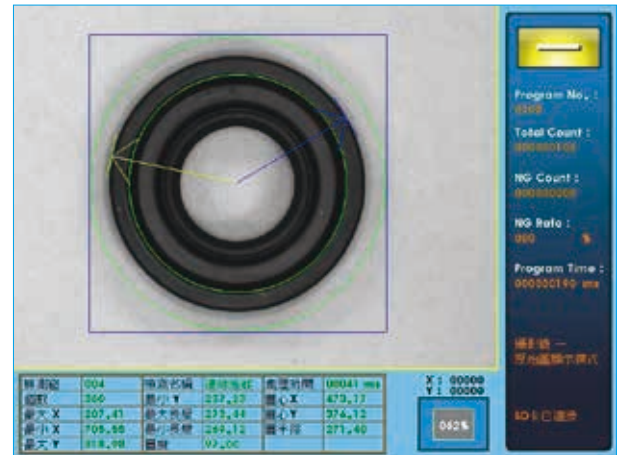
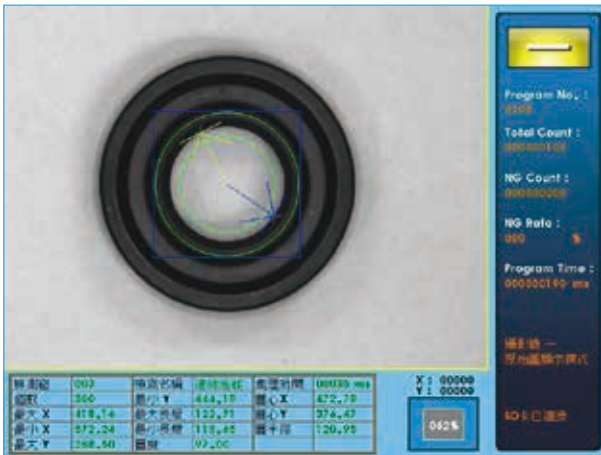

【Process】

1. When the rubber gasket enters the inspection area, the DMV Series starts to capture images
2. The DMV Series sends the OK/NG signals to the controller via I/O communication; if the result shows NG, the controller will send an order to remove the defect products

Advantages of DMV system

The DMV Series enhances productivity and reduces defect rate for manufacturers

Rubber and Plastics



Inspection Objectives

Inspection of self-tapping screw on plastic workpiece

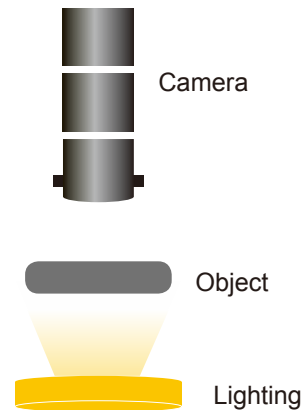

Device Configuration

Controller	DMV1000 (also applicable with DMV2000)
Camera	DMV-CD30GS
Lens	12 mm focal length
Illumination	Back light
Working distance	93 mm
FOV	40 mm x 30 mm

【 Inspecting Tool 】

Use the "Edge Position" function to inspect the height of a locked screw, and use the "Edge Angle" function to inspect whether the locked screw is tilted

【 Key Point 】

Acquire the clear screw outline with a back light to get the most precise results when measuring position and angles

【Result】

- Inspection speed: within 120 ms
- Inspecting the height and angle of the locked screw helps ensure the plastic workpiece is fixed on the furniture

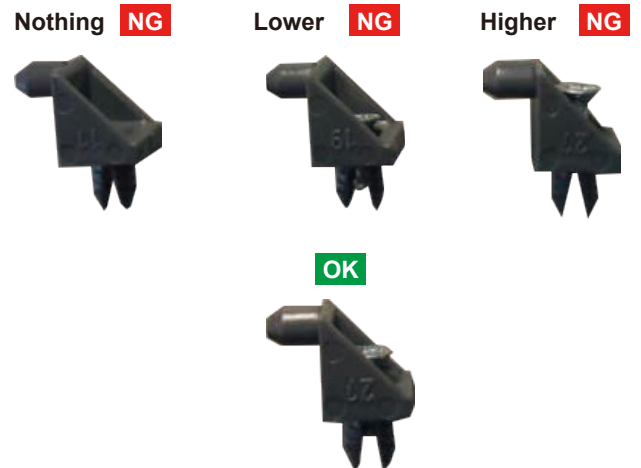
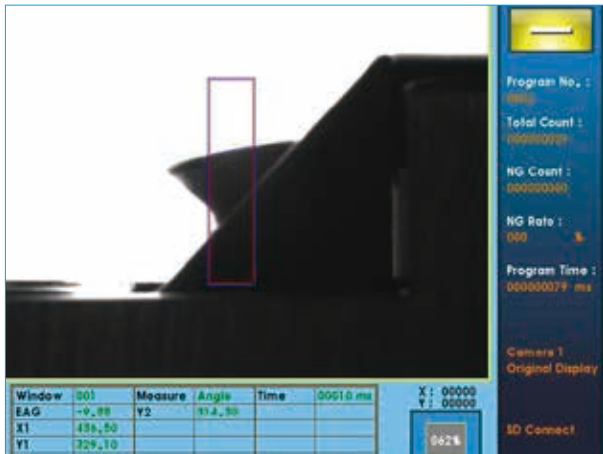

【Process】

The feeding plate sends the material to the detection area. With the sharp outline by back light, the system inspects the height and the angle of the locked screw

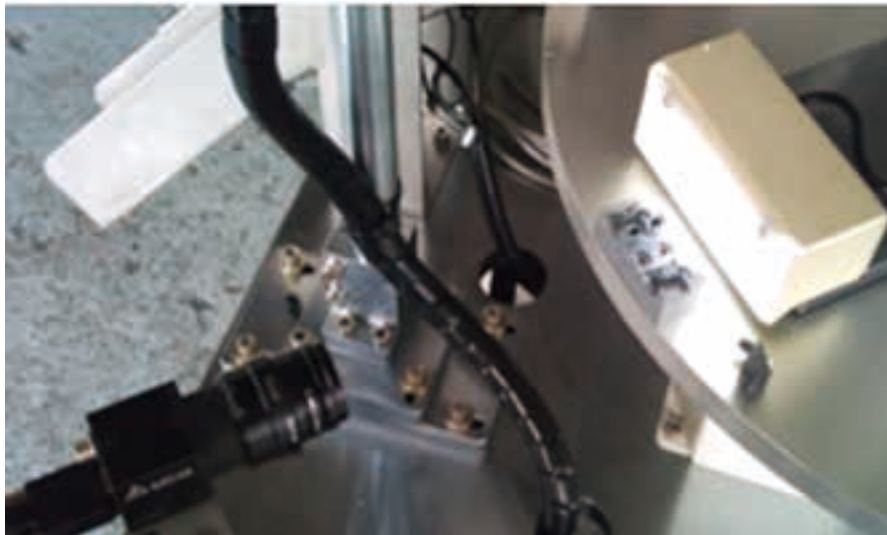

Advantages of DMV system

This solution achieves high-speed inspection, enhancing production efficiency

Rubber and Plastics



Inspection Objectives

Plastic bottle and washer inspection

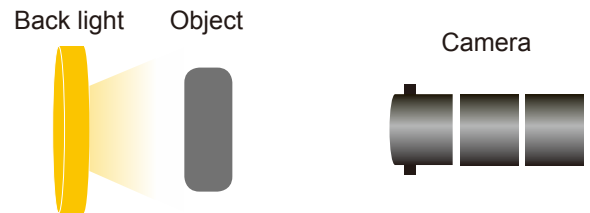

Device Configuration

Controller	DMV1000 (also applicable with DMV2000)
Camera	DMV-CD80GS
Lens	12 mm focal length
Illumination	White back light
Working distance	approx. 160 mm
FOV	approx. 65 mm x 49 mm

【 Inspecting Tool 】

- Use 2 "Edge Position" functions to position coordinates, and then use the "Area" function to confirm the presence of the cap
- Use the "Edge Width" function to inspect the fixing clip

【 Key Point 】

Use the back light to clearly contrast the bottle outline and enhance measuring precision

【Result】

- Inspection speed: within 150 ms; when the workpiece enters the inspection area, the DMV Series inspects whether the plastic cap and the fixing clip are present
- When the object enters the inspection area, the DMV Series uses the "Area" function to inspect whether the plastic cap and the fixing clip are installed; if the cap is there, the black area will be over 18,000 pixels

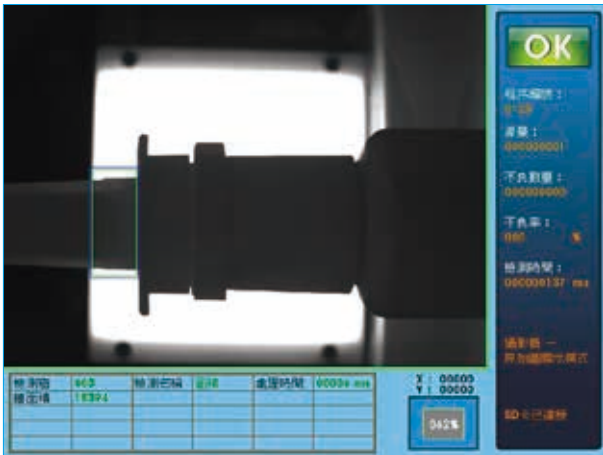

- Use the "Edge width" function to inspect the plastic clips; if a clip is present, the width value will be over 250 pixels

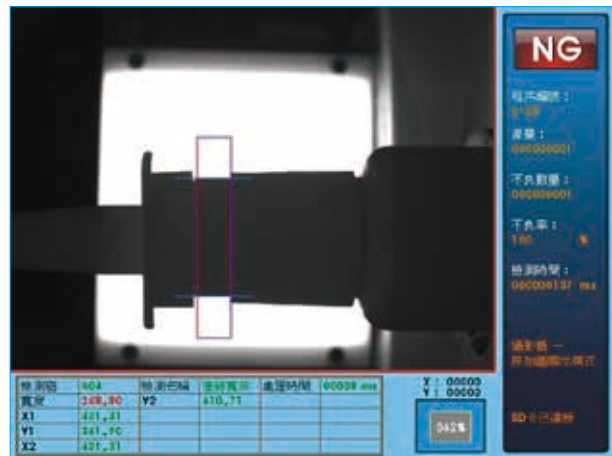
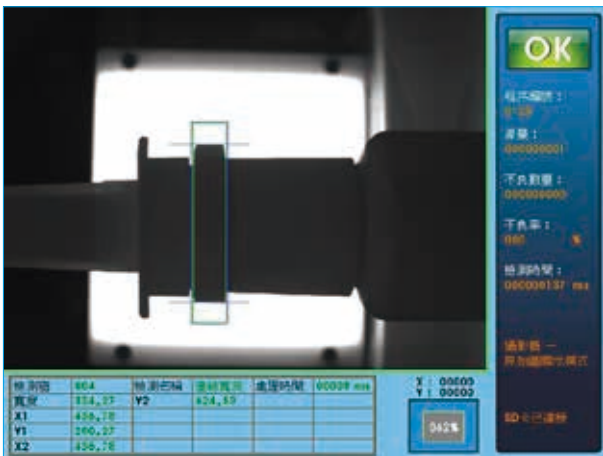

【Process】

1. After the workpiece is sent to the inspection area, the DMV Series starts to capture images
2. The DMV Series sends the OK/NG signals to the controller via I/O communication; if the result is NG, the controller will send a defect removal command

Advantages of DMV system

The DMV Series can correctly inspect whether the plastic bottles are mis-installed or lack of parts, reducing defect rate

Packaging



Inspection Objectives

Package barcode inspection

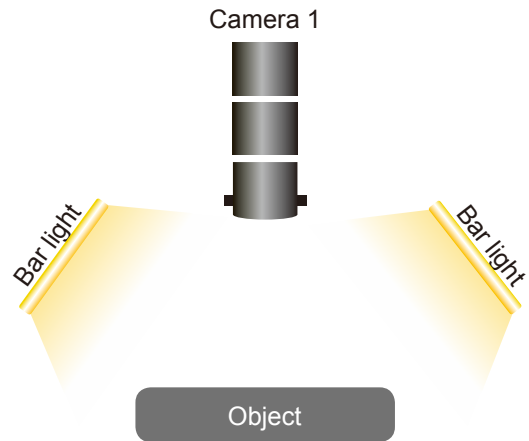

Device Configuration

Controller	DMV1000 (also applicable with DMV2000)
Camera	DMV-CD80GS
Lens	12 mm focal length
Illumination	White bar light *2
Working distance	Approx. 210 mm
FOV	Approx. 154 mm x 115.5 mm

【 Inspecting Tool 】

Use the "Shape" function to position the printed "Free Scan Now" characters, and then use the "Bar Code" function to scan the 1-D and the 2-D barcodes on the workpiece

【 Key Point 】

- The lighting needs to contrast the barcodes
- Positioning functions are suggested to prevent offset

【Result】

- Inspection speed: within 300 ms
- As soon as the barcode is scanned, the system will show the result



【Process】

- When a workpiece is sent to the inspection area, the DMV Series starts to capture images
- The DMV Series sends the OK/NG signals to the controller via I/O communication; if the result shows NG, the controller will trigger an output to inform operators for alert

Advantages of DMV system

The integration of the DMV Series greatly reduces the chance of incorrect printing and feeding

Packaging



Inspection Objectives

Coffee filter inspection

Use the DMV Series to inspect whether the number of coffee filters is correct. A normal product contains 1 filter; while a defect contains 2 or more, or no filters

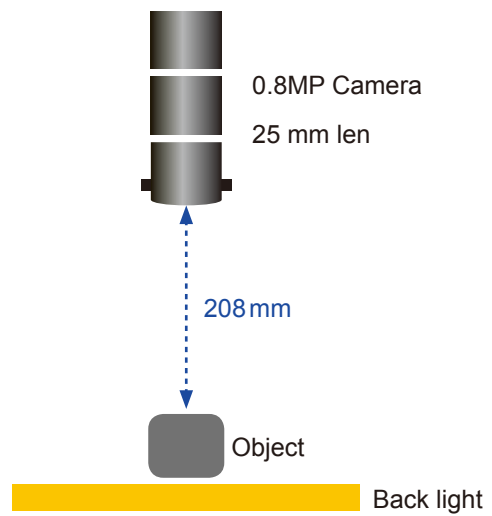
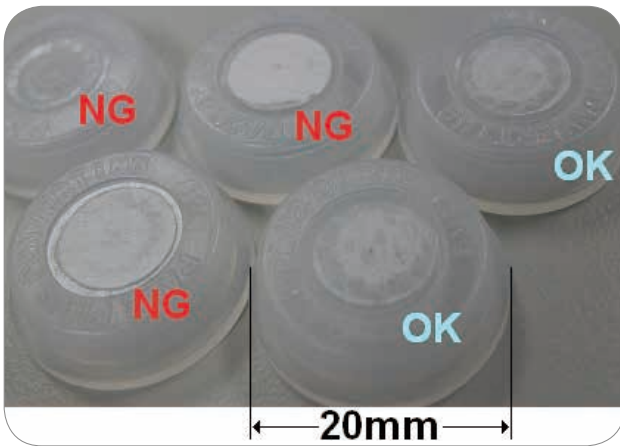

Device Configuration

Controller	DMV1000 (also applicable with DMV2000)
Camera	DMV-CD80GS
Lens	25 mm focal length
Illumination	Back light
Working distance	208 mm
FOV	40 mm x 30 mm

【 Inspecting Tool 】

Use the "Shape" function to position the coffee filter, and then use the "Intensity" function to inspect the number of the filters

【 Key Point 】

- The number of filters affects transparency, which is how the DMV Series determines the number of coffee filters
- A hollow-type conveyor is required for the back light to transmit through the back of the conveyor belt

【Result】

- The normal product contains only 1 filter, with an average image intensity of 165
- When it contains 2 filters, the average image intensity reduces to 132

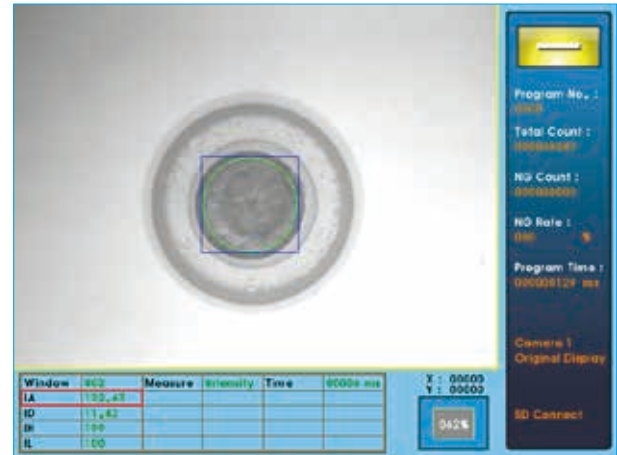
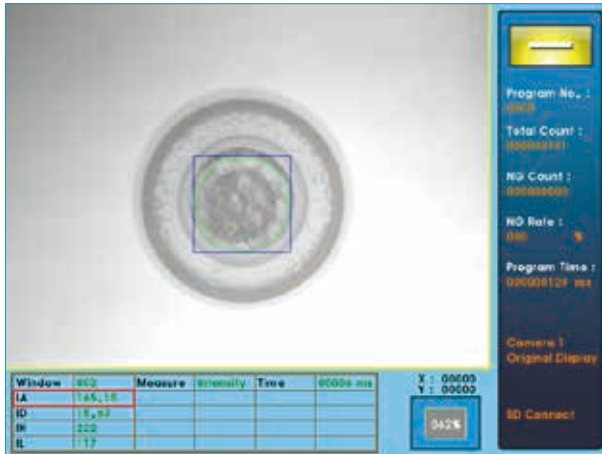

- When it contains no filters, the average image intensity goes up to 220



【Process】

- The conveyor belt sends the coffee filters to the inspection area. The ones with the correct number of filters continue, and the ones with incorrect numbers or none are discarded

Advantages of DMV system

This application fulfills the requirement for automatic inspection after assembly

Packaging



Inspection Objectives

Inspection of face mask outer packages

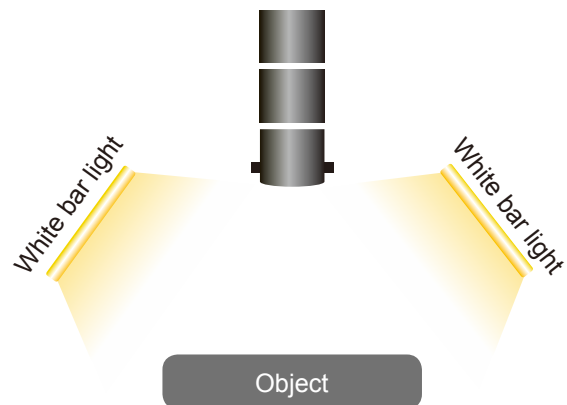

Device Configuration

Controller	DMV1000 (also applicable with DMV2000)
Camera	DMV-CD30GS
Lens	12 mm focal length
Illumination	white bar light x 2
Working distance	Approx. 383.3 mm
FOV	Approx. 153.3 mm x 115 mm

【 Inspecting Tool 】

- Use the "Shape" function to locate the position
- Then use 2 "Area" functions to check the manufactured dates and security label individually

【 Key Point 】

Using lighting on two sides effectively reduces deviant inspection of the outer package caused by glare

【Result】

- Inspection speed: within 150 ms
- When the workpiece enters the inspection area, the DMV Series will inspect the MFD and the security label printed on the outer package
- Using the "Area" function to check whether the outer package is printed with MFD
- The following figure shows the outer package without MFD and judged an NG product



- Using the "Area" function to check whether the outer package is printed with a security label (The figure is shown with a barcode label)
- The following figure shows the outer package without a security label and judged as an NG product (The figure is shown without a barcode label)



【Process】

- When the object enters the inspection area, the controller triggers the DMV Series to capture images
- The DMV Series will send OK/NG signals to the controller via I/O; if the result shows NG, the controller will remove the product

Advantages of DMV system

The DMV Series fulfills the need for checking any mis-printings or misplaced stickers on the outer packages and reduces defective products

Packaging



Inspection Objectives

Cosmetic sprayer inspection

Use the DMV Series to confirm whether the number of the steel ball in the sprayer is correct



Device Configuration

Controller	DMV1000 (also applicable with DMV2000)
Camera	DMV-CD30GS
Lens	25 mm focal length
Illumination	Back light
Working distance	208 mm
FOV	40 mm x 30 mm

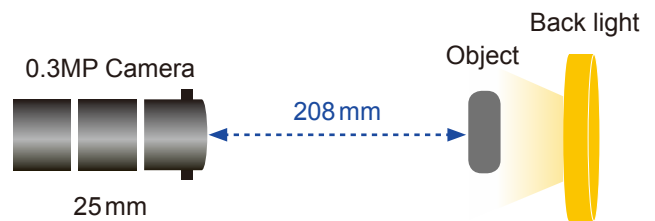

【 Inspecting Tool 】

Use the "Shape" function to position the sprayer, and then use the "Area" function to inspect the number of the steel balls in the sprayer

【 Key Point 】

Use the back light to enhance contrast of the steel balls

【Result】

- When there is one steel ball, the black area is around 1,935 pixels, which is a normal value
- When there is no steel ball in the sprayer, the black area is around 345 pixels, which is an error value



- When there are 2 steel balls in the sprayer, the black area is around 2,662 pixels, which is an error value



【Process】

Place the sprayer onto the track and engage feeding via vibration. After the sprayer enters the inspection area, sensors trigger the DMV to capture images. If a defect is detected, the equipment is paused for rework; or the process continues if the detection result is OK

Advantages of DMV system

This solution achieves automatic inspection after assembly

Printing



Inspection Objectives

Inspection of ink load for printing plates

Inspect whether ink insufficiency occurs in the ink area

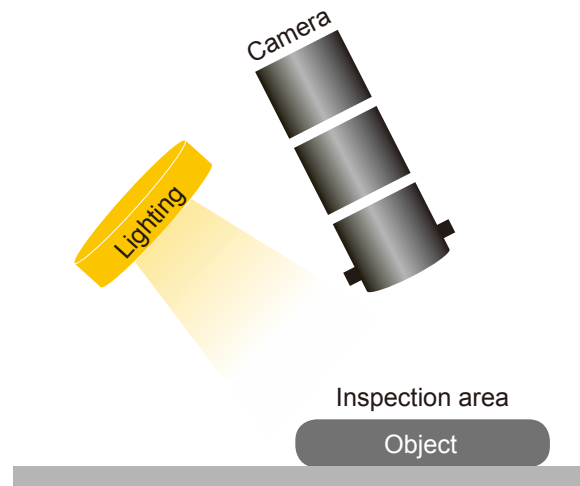
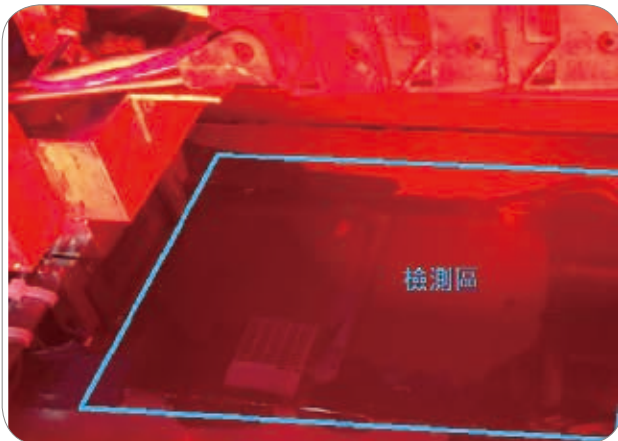

Device Configuration

Controller	DMV1000 (also applicable with DMV2000)
Camera	DMV-CD80GS
Lens	12 mm focal length
Illumination	backlight
Working distance	760 mm
FOV	300 mm x 225 mm

【Inspecting Tool】

Use the "Blob" function for inspection

【Key Point】

- While screening ink, the two sides of the squeegee contain less ink than the middle part, causing uneven ink distribution
- The DMV Series determines the ink load by inspecting printing quality

【Result】

Inspection speed: within 160 ms



【Process】

When the printing squeegee retreats, the DMV Series inspects the printing area to determine the ink load. If too many blobs are detected, the control system of the machine will judge the message as insufficient ink and trigger the auto ink refill process

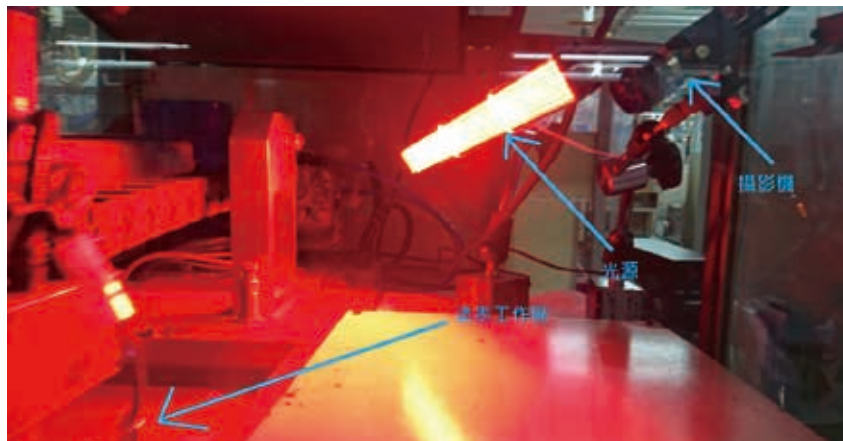

Advantages of DMV system

The DMV Series detects the printing quality to determine insufficient ink load conditions, and informs the machine to reload ink by sending an alert, preventing printing defects

Printing



Inspection Objectives

Inspection of scratches on printed films

Inspect if there is any damage on the printed films (ex: light scratches)



Device Configuration

Controller	DMV1000 (also applicable with DMV2000)
Camera	DMV-CD80GS
Lens	6 mm focal length
Illumination	indoor lighting with fluorescent lamp, particular lighting not required
Working distance	450 mm
FOV	350 mm x 260 mm

【 Inspecting Tool 】

Use the "Edge Count" function to detect; if the DMV Series shows numbers in the result, it means scratches exist on the films

【 Key Point 】

- Since scratches are light-colored, it is suggested to use 3 "Edge Count " functions at the same time to precisely detect scratches on the printed films
- The printed film is thin and white, so a dark-colored background is suggested for contrasting scratches

【Result】

- Inspection speed: within 160 ms
- The DMV Series stably inspects scratches of approximately 0.3 mm or above

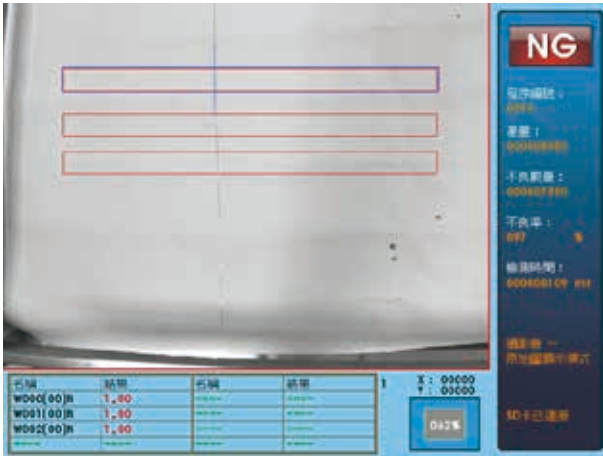

【Process】

When the DMV Series detects scratches, the result is delivered to the master controller via I/O communication, informing on-site personnel to troubleshoot

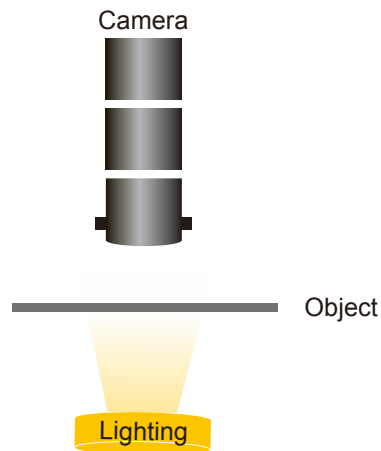

Advantages of DMV system

In printing film manufacturing , human visual printing quality inspection is slow in speed and unstable in quality. The DMV Series helps achieve a timely inspection to avoid massive printing defects

Printing



Inspection Objectives

Inspection of printing quality on metal workpiece

Inspect the gray circle printing area on the metal workpiece and identify if containing any black / white spots or scratches

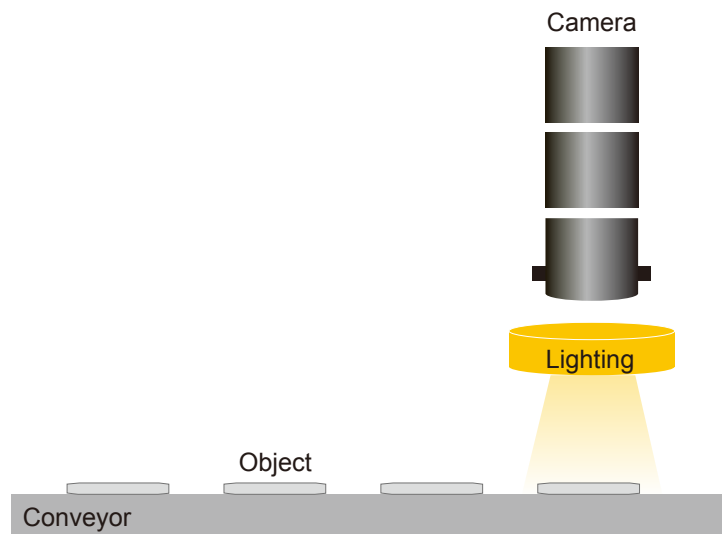
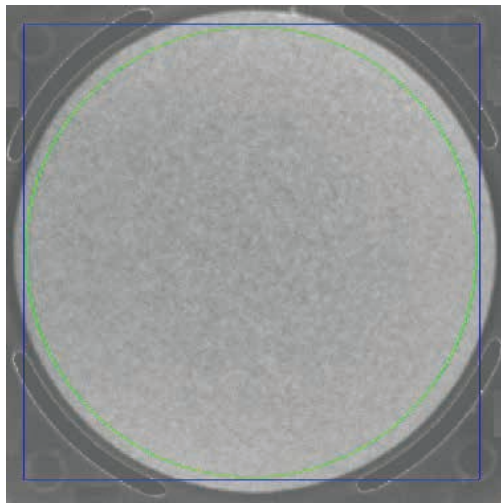

Device Configuration

Controller	DMV1000 (also applicable with DMV2000)
Camera	DMV-CD80GS
Lens	12 mm focal length + 1.5 mm extension ring
Illumination	White ring lighting at low angle
Working distance	70 mm
FOV	30 mm x 22 mm

【 Inspecting Tool 】

- Use the "Shape" function to position the metal workpiece
- Use the "Stain" function to track the circle area positioned by the previous "Shape" function; if any uneven image variation is inspected, it will be recognized as a stain

【 Key Point 】

The "Stain" function, matched with a low angle lighting for contrasting, can easily identify the stains on the printing surface

【Result】

- Inspection speed: within 170 ms
- The DMV Series can stably inspect stains of over 70 μm

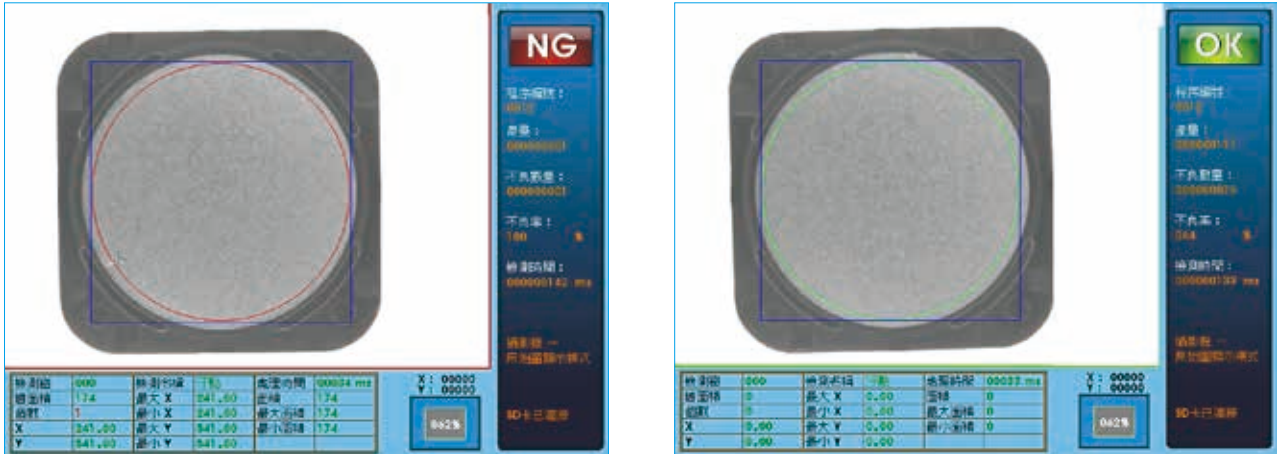

【Process】

Use servo motors to drive the ball screw for feeding and posing of each workpiece; When a workpiece enters the inspection area, the DMV system captures images via a camera for visual inspection, and identifies the printing quality of the workpiece

Advantages of DMV system

Human visual inspection can hardly examine the trivial stains, especially under long working hours and fatigue. The DMV Series allows users to self-define the stain size for inspection to achieve stable, high-quality process, as well as to avoid inconsistent standards of manpower operation

Pharmaceuticals



Inspection Objectives

Verification of expiration date (EXP) on medication bottles

Expiry Date

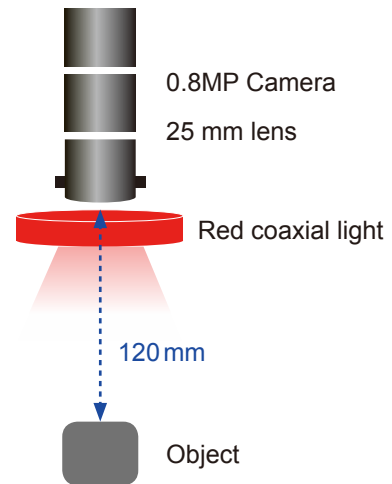

Device Configuration

Controller	DMV1000 (also applicable with DMV2000)
Camera	DMV-CD80GS
Lens	12 mm focal length
Illumination	Red coaxial light
Working distance	120 mm
FOV	50 mm x 38 mm

【 Inspecting Tool 】

Use the "Shape" function to locate specific wordings (e.g. LOT number or EXP printed on the measurand), then use the "Optical Character Verification (OCV)" function to identify the correctness

【 Key Point 】

The fonts of the laser-printed wordings on the medicine bottle may be inconsistent. To ensure inspection stability with OCV function, apply a variety of character fonts in the DMV Series in advance to guarantee correct identification of the same wordings

【Result】

- The following figure shows that the DMV Series successfully identified the EXP on the medicine bottle, which is 20181225



【Process】

After the DMV Series sends the inspection result to the controller, it will judge whether the EXP is correct or not.

Advantages of DMV system

The DMV Series fulfills requirements for the auto-inspection of printed markings

Pharmaceuticals



Inspection Objectives

Tablet quality inspection

Use the DMV Series to inspect tablet quality, shape, and edge



Device Configuration

Controller	DMV2000		
Camera 1	DMV-CM30GCL	Camera 2	DMV-CM30GCL
Lens	16 mm focal length + 2 mm extension ring	Lens	16 mm focal length + 2 mm extension ring
Illumination	blue dome light	Illumination	Ring light at low angle
Working distance	89 mm	Working distance	89 mm
FOV	30 mm x 23 mm	FOV	30 mm x 23 mm

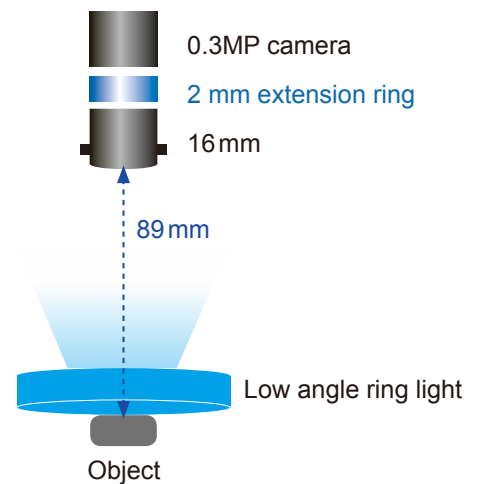
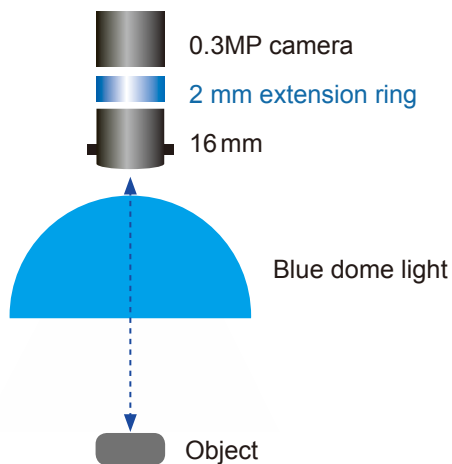

【Inspecting Tool】

- Use the "Shape" function to position tablets
- Use the "Blob" function to inspect stains on tablets
- Use the "Edge Count" function to inspect damaged edges and shapes of tablets

【Key Point】

- Use 2 cameras for inspection: one is matched with a blue dome light to inspect tablet stains, while the other is matched with a low angle ring light to inspect damaged edges and shapes of tablets
- Inspection speed is controlled within 72 ms, reaching inspection efficiency of 400,000 tablets in 8 hours

【Result】

The DMV Series correctly inspects stains or damaged parts on each tablet within 30 ms

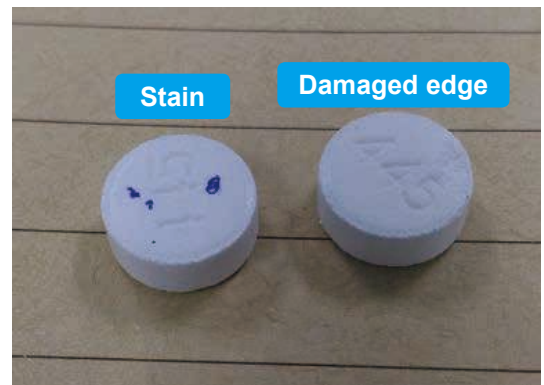

【Process】

When the tablets are sent to the inspection area, the sensor triggers the DMV 2000 Series for inspection. The qualified products will proceed, whereas the defective ones will be picked out

Advantages of DMV system

The DMV2000 Series can replace human visual inspection to reduce defect rate

Pharmaceuticals



Inspection Objectives

Inspection of tag position on medication packaging

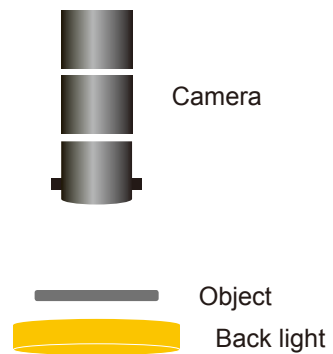

Device Configuration

Controller	DMV1000 (also applicable with DMV2000)
Camera	DMV-CD80GS
Lens	12mm focal length
Illumination	Back light
Working distance	160 mm
FOV	100 mm x 75 mm

【 Inspecting Tool 】

- Use the "Shape" function to position a roll of 5 transparent medication pods
- Use 5 "Area" functions to inspect the position of every label on the 5 pods

【Key Point】

- The DMV Series inspects stains and damages on the 5 labels within 72 ms
- Use 5 "Area" functions to inspect the labels' black area after the pods are positioned
- If the position of the medication pods is offset, the DMV Series automatically coordinates the pods based on the previous positioning

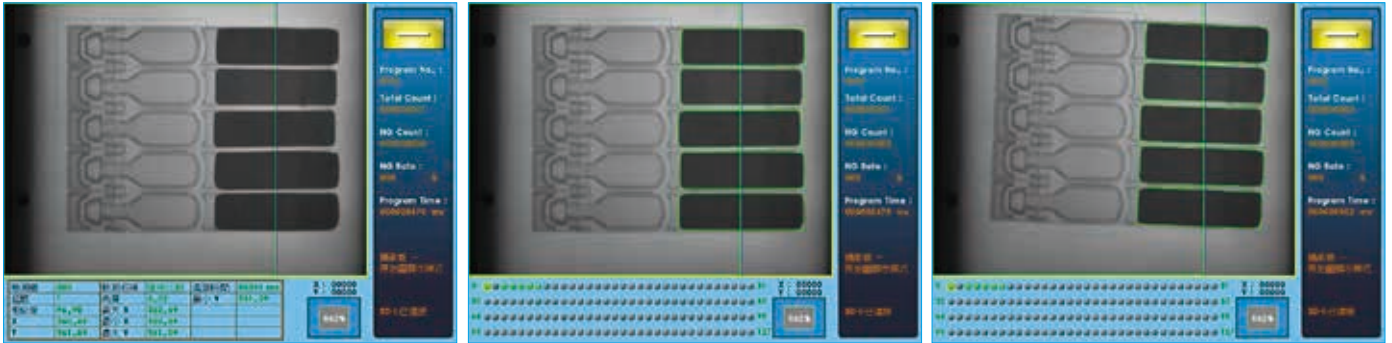

【Result】

- Inspection speed: within 600 ms
- The DMV Series achieves stable and correct inspection even when the pod position is offset

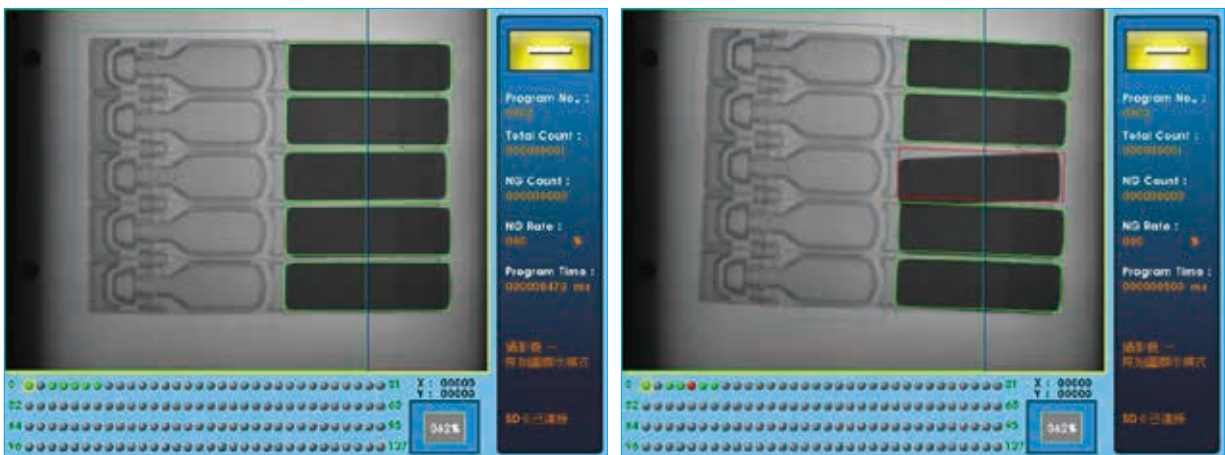

【Process】

Use a clamping device to pick up the workpiece to the feeding plate for inspection

Advantages of DMV system

The DMV Series can replace human visual inspection to reduce defect rate

Other



Inspection Objectives

Soldering spot coordinate identification on solar modules

Use the DMV Series to inspect the soldering spot coordinates according to Y coordinate

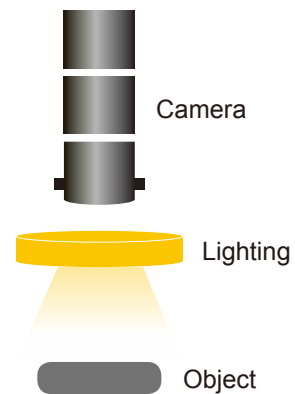
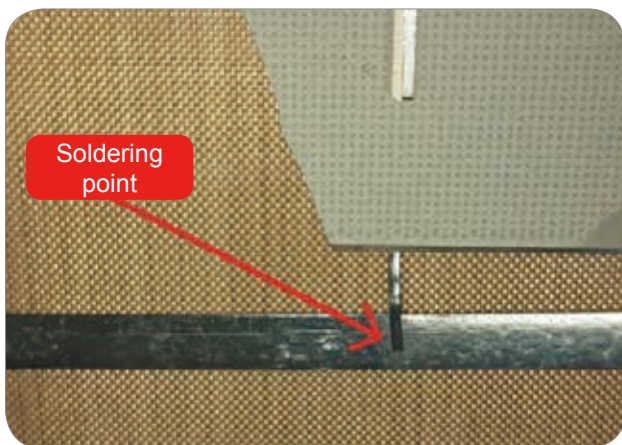

Device Configuration

Controller	DMV1000 (also applicable with DMV2000)
Camera	DMV-CD80GS
Lens	12 mm focal length
Illumination	white top ring light
Working distance	95 mm
FOV	40 mm x 30 mm

【 Inspecting Tool 】

Use 2 "Edge Position" functions to position the X-Y coordinates

【 Key Point 】

- Use the "Edge Position" functions to position the Y coordinate on the thick metal strip
- Then position the X coordinate on the thin metal strip with the Y coordinate as a reference

【Result】

- Inspection speed: within 200 ms / position precision: within 1 mm to fulfill inspection requirements of 2-mm-width metal strip
- First, position the Y coordinate of the thick metal strip
- Then position the X coordinate on the thin metal strip according to the Y coordinate

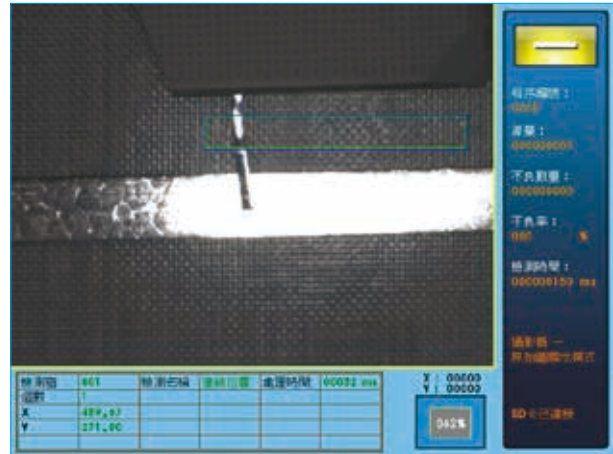
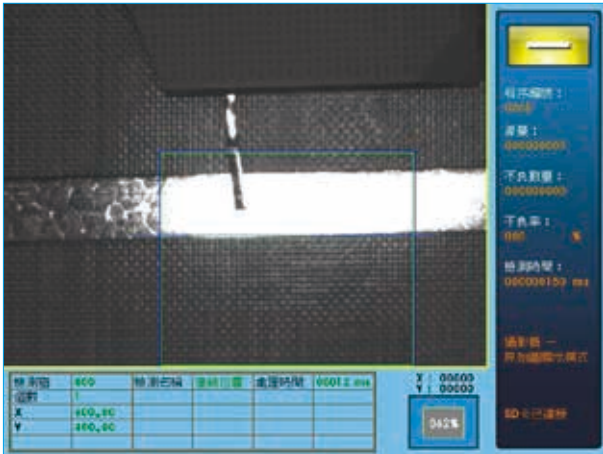

【Process】

Use the X-Y platform to coordinate the offset solar modules for precise soldering

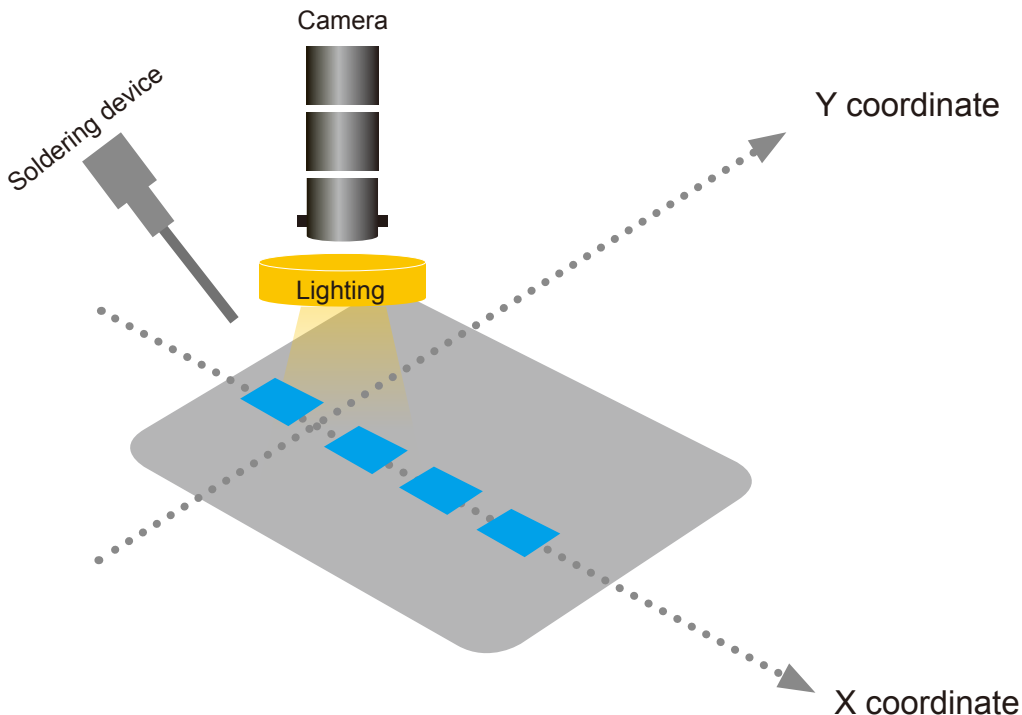

Advantages of DMV system

The solar modules present a large area that is difficult for manual soldering. The DMV Series assists the automatic soldering process, and replaces workers to prevent labor health hazards

Other



Inspection Objectives

Metal rivet inspection

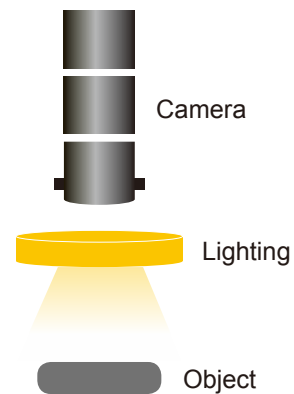

Device Configuration

Controller	DMV1000 (also applicable with DMV2000)
Camera	DMV-CD80GS
Lens	50 mm focal length + 10 mm extension ring
Illumination	White ring light
Working distance	180 mm
FOV	15 mm x 11 mm

【 Inspecting Tool 】

Use the "Area" function to inspect the black pixels and judge whether the workpiece contains a rivet inside

【 Key Point 】

- Because the metal workpiece is highly reflective, make sure the lighting is evenly cast during inspection
- A workpiece without a rivet shows a large area of white exposure under a proper lighting angle, whereas one with a rivet shows a shadow caused by light reflection. The DMV Series uses these differences to identify whether the workpiece contains a rivet

【Result】

- Inspection speed: within 150 ms
- The DMV Series stably and correctly complete inspection by recognizing an obvious contrast between presence / absence of a rivet
- When the workpiece contains a rivet, the black area value is 1,153 pixels as the system shows it as a good product (OK)
- When the workpiece contains no rivets, the black area value is 0 as the system shows it as an NG product

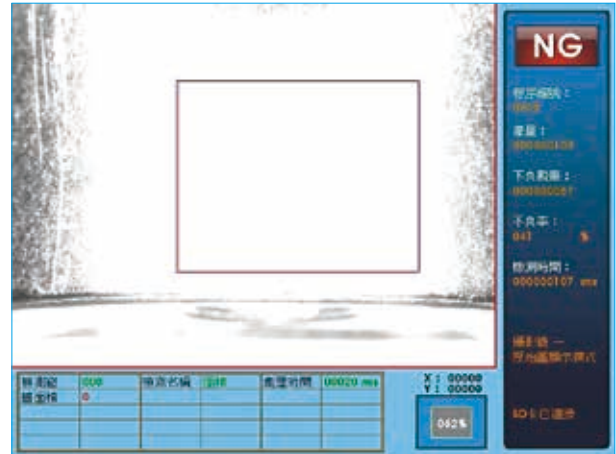

【Process】

The part feeder sends the workpiece to the rotary index table, and then the DMV Series inspects workpiece by workpiece; when the system shows NG, the product will be discarded on the next stop

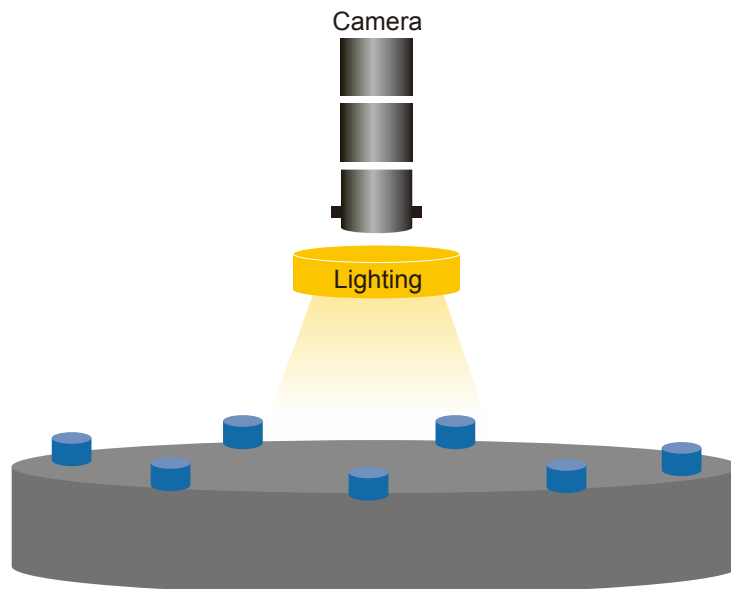

Advantages of DMV system

Using the rotary index table during workpiece manufacturing, this application installs the DMV Series at one of the production stops to stably inspect the material quality. The DMV Series features high-speed inspection capabilities without affecting the overall production speed after installation on the production line, achieving a high-efficiency and stable machine vision application

Other

Inspection Objectives

Ceramic tile inspection

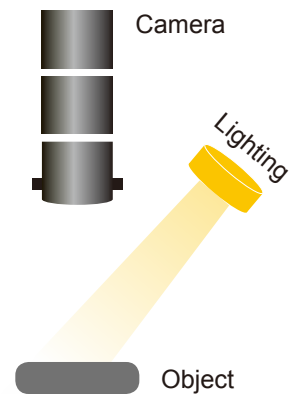

Device Configuration

Controller	DMV1000 (also applicable with DMV2000)
Camera	DMV-CD30GS
Lens	12 mm focal length
Illumination	White ring light, with side lighting
Working distance	180 mm
FOV	75 mm x 56 mm

【 Inspecting Tool 】

Use the "Edge Count" function to inspect the front and rear sides of the ceramic tile

【 Key Point 】

The front side of the ceramic tile is smooth and the rear side is grooved. The DMV Series uses the shadows caused by the grooved patterns to identify the front and rear sides of the ceramic tile

【Result】

- Inspection speed: within 130 ms
- The front and rear sides of the ceramic tiles are significantly different, resulting in stable and consistent inspection
- The "Edge Count" function shows the measurement is 0, meaning the ceramic tiles is at the front side
- The "Edge Count" function shows the measurement is more than 0, meaning the ceramic tiles is at the back side

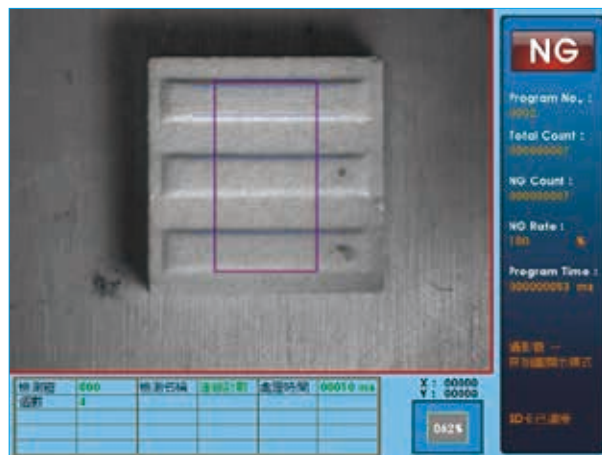

【Process】

The conveyor belt sends the ceramic tiles to the inspection area, and the sensor triggers the DMV Series to inspect; the rear sided tiles are blown away by air to ensure consistency

Advantages of DMV system

Ceramic tiles are generally dusty, small and in large amount. The DMV Series provides a faster and stabler scanning process and replaces manpower to prevent health hazards caused by dust

Other



Inspection Objectives

Inspection of hollow direction on metal workpiece

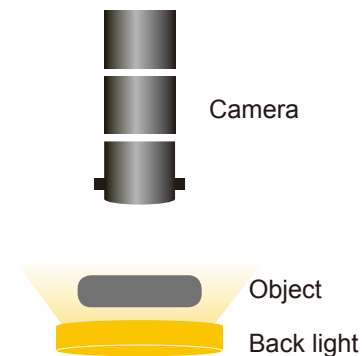

Device Configuration

Controller	DMV1000 (also applicable with DMV2000)
Camera	DMV-CD30GS
Lens	12 mm focal length
Illumination	Back light
Working distance	90 mm
FOV	40 mm x 30 mm

【 Inspecting Tool 】

- Use the 2 "Width Trace" functions to inspect the two ends of an iron pipe; the one with a smaller width value is the hollow side (right side)
- Then use the "Calculator" function to identify the hollow side of the iron pipe

【 Key Point 】

The "Width Trace" function is able to inspect the smallest width in the inspection area, without extra measurement tools

【Result】

- Inspection speed: within 120 ms
- Use the "Width Trace" function to inspect the left side of the iron pipe: the result shows the width is 118.64 pixels
- Use the "Width Trace" function again to inspect the right side of the iron pipe: the result shows the width is 110.40 pixels. The right width is smaller than the left width, meaning the iron hollow is at the right-hand side

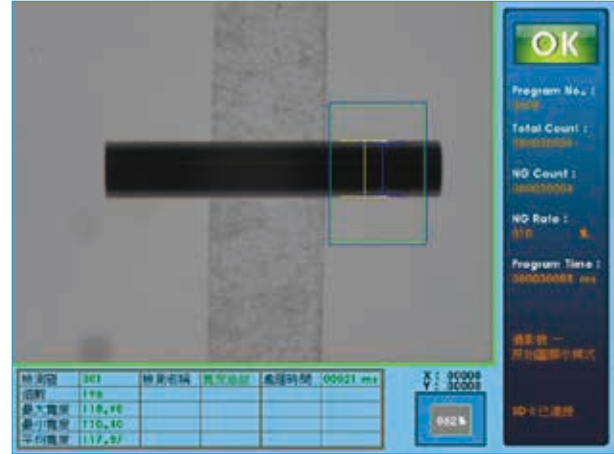
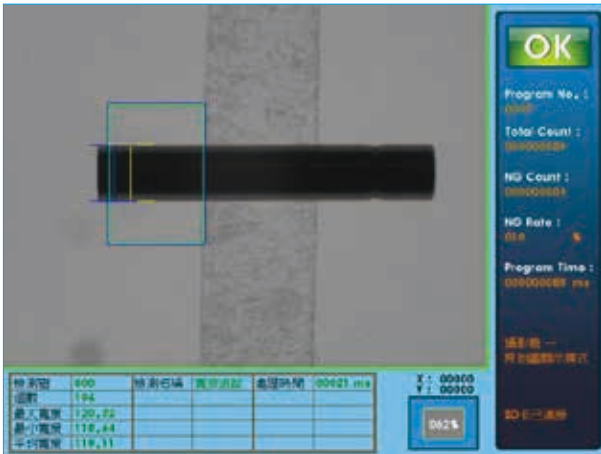

- With the above results, the "Calculator" function is able to identify the hollow side of the iron pipe

【Process】

The vibratory feeder sends the iron pipes to the index table, then the front camera inspects the hollow width of the iron pipe with back lighting to show the edge outline

Advantages of DMV system

The hollow width of iron pipes is tiny, and it is hard for general inspection equipment to rapidly and precisely measure. The DMV Series is able to accomplish measurement and detection without damaging the iron pipes

Global Operations

ASIA (Taiwan)



Taoyuan Technology Center (Green Building)



Taoyuan Plant 1



Taoyuan Plant (Diamond-rated Green Building)

ASIA (China)



Wujiang Plant 3



Delta Electronics

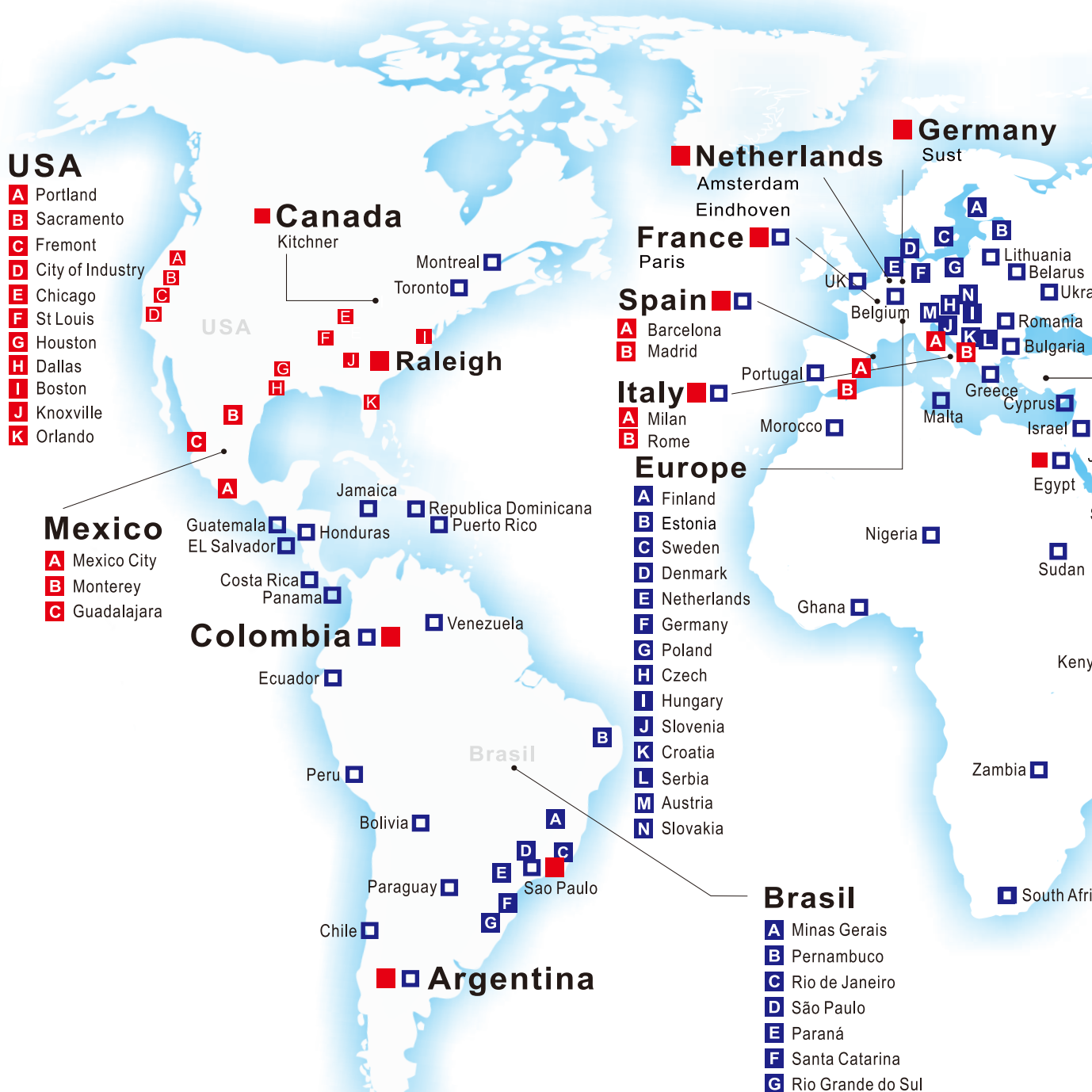

ASIA (Japan)



Tokyo Office

ASIA (India)



Rudrapur Plant (Green Building)

EUROPE



Amsterdam, Netherlands

AMERICA



Research Triangle Park

▲ Factories 4 ■ Branch Offices 122 ● R&D Centers 5 ▣ Distributors 733





Smarter. Greener. Together.

Industrial Automation Headquarters

Delta Electronics, Inc.

Taoyuan Technology Center
No.18, Xinglong Rd., Taoyuan District,
Taoyuan City 33068, Taiwan
TEL: 886-3-362-6301 / FAX: 886-3-371-6301

Asia

Delta Electronics (Shanghai) Co., Ltd.

No.182 Minyu Rd., Pudong Shanghai, P.R.C.
Post code : 201209
TEL: 86-21-6872-3988 / FAX: 86-21-6872-3996
Customer Service: 400-820-9595

Delta Electronics (Japan), Inc.

Tokyo Office
Industrial Automation Sales Department
2-1-14 Shibadaimon, Minato-ku
Tokyo, Japan 105-0012
TEL: 81-3-5733-1155 / FAX: 81-3-5733-1255

Delta Electronics (Korea), Inc.

Seoul Office
1511, 219, Gasan Digital 1-Ro., Geumcheon-gu,
Seoul, 08501 South Korea
TEL: 82-2-515-5305 / FAX: 82-2-515-5302

Delta Energy Systems (Singapore) Pte Ltd.

4 Kaki Bukit Avenue 1, #05-04, Singapore 417939
TEL: 65-6747-5155 / FAX: 65-6744-9228

Delta Electronics (India) Pvt. Ltd.

Plot No.43, Sector 35, HSIIDC Gurgaon,
PIN 122001, Haryana, India
TEL: 91-124-4874900 / FAX : 91-124-4874945

Delta Electronics (Thailand) PCL.

909 Soi 9, Moo 4, Bangpoo Industrial Estate (E.P.Z),
Pattana 1 Rd., T.Phraksa, A.Muang,
Samutprakarn 10280, Thailand
TEL: 66-2709-2800 / FAX : 662-709-2827

Delta Energy Systems (Australia) Pty Ltd.

Unit 20-21/45 Normanby Rd., Nottling Hill Vic 3168, Australia
TEL: 61-3-9543-3720

Americas

Delta Electronics (Americas) Ltd.

Raleigh Office
P.O. Box 12173, 5101 Davis Drive,
Research Triangle Park, NC 27709, U.S.A.
TEL: 1-919-767-3813 / FAX: 1-919-767-3969

Delta Greentech (Brasil) S/A

São Paulo Office
Rua Itapeva, 26 – 3° Andar - Bela Vista
CEP: 01332-000 – São Paulo – SP - Brasil
TEL: 55-11-3530-8642 / 55-11-3530-8640

Delta Electronics International Mexico S.A. de C.V.

Mexico Office
Vía Dr. Gustavo Baz No. 2160, Colonia La Loma,
54060 Tlalnepantla Estado de Mexico
TEL: 52-55-2628-3015 #3050/3052

EMEA

Delta Electronics (Netherlands) BV

Eindhoven Office
De Witbogt 20, 5652 AG Eindhoven, The Netherlands
MAIL: Sales.IA.EMEA@deltaww.com
MAIL: Sales.IA.Benelux@deltaww.com

Delta Electronics (France) S.A.

ZI du bois Chaland 2 15 rue des Pyrénées,
Lisses 91056 Evry Cedex, France
MAIL: Sales.IA.FR@deltaww.com

Delta Electronics Solutions (Spain) S.L.U

Ctra. De Villaverde a Vallecas, 265 1° Dcha Ed.
Hormigueras – P.I. de Vallecas 28031 Madrid
C/Llull, 321-329 (Edificio CINC) | 22@Barcelona, 08019 Barcelona
MAIL: Sales.IA.Iberia@deltaww.com

Delta Electronics (Italy) Srl

Ufficio di Milano Via Senigallia 18/2 20161 Milano (MI)
Piazza Grazioli 18 00186 Roma, Italy
MAIL: Sales.IA.Italy@deltaww.com

Delta Electronics (Germany) GmbH

Coesterweg 45, D-59494 Soest, Germany
MAIL: Sales.IA.DACH@deltaww.com

Delta Energy Systems LLC (CIS)

Vereyskaya Plaza II, office 112 Vereyskaya str.
17 121357 Moscow, Russia
MAIL: Sales.IA.RU@deltaww.com

Delta Greentech Ltd. (Turkiye)

Serifali Mevkii Barbaros Bulvari Soylesi Sok
No 19 34775, Y.Dudullu-Umraniye/Istanbul
MAIL: Sales.IA.Turkey@delta-emea.com

Delta Energy Systems AG (Dubai BR)

P.O. Box 185668, Gate 7, 3rd Floor, Hamarain Centre,
Dubai, United Arab Emirates
MAIL: Sales.IA.MEA@deltaww.com